

# Limfjord tunnel Assessment and retrofitting

Technical Summary Report, Version 1.0

Date 25. juni 2019

**ATKINS**  
Member of the SNC-Lavalin Group

**COWI**

  
**Christiansen  
& Essenbæk**

 Delta Marine  
Consultants

**nmGeo**

**RAMBOLL**

**TEC** Tunnel Engineering Consultants

# List of contents

<b>1</b>	<b>Executive Summary.....</b>	<b>6</b>
<b>2</b>	<b>Background and objectives.....</b>	<b>10</b>
	2.1 Introduction .....	10
	2.2 Methodology .....	12
<b>3</b>	<b>References.....</b>	<b>14</b>
	3.1 Normative references .....	14
	3.2 Background documents .....	14
<b>4</b>	<b>Description of tunnel.....</b>	<b>16</b>
	4.1 Structural layout.....	16
	4.2 Soil conditions.....	18
	4.3 Construction method.....	19
	4.3.1 <i>Earth works</i> .....	19
	4.3.2 <i>Concrete works</i> .....	21
	4.3.3 <i>Installation of elements</i> .....	22
	4.3.4 <i>Joints</i> .....	24
	4.3.5 <i>Waterproofing membrane</i> .....	25
	4.4 Early defects .....	26
	4.4.1 <i>Leakage</i> .....	26
	4.4.2 <i>Settlement and deformation monitoring</i> .....	27
	4.5 Repair and strengthening works.....	27
	4.5.1 <i>Background</i> .....	27
	4.5.2 <i>Activities (1990 – 2018)</i> .....	28
	4.5.3 <i>Current activities</i> .....	30
	4.5.3.1 <i>Crack injection campaigns</i> .....	30
	4.5.3.2 <i>Other activities</i> .....	31
	4.6 Recorded settlements.....	31
<b>5</b>	<b>Geotechnical assessment.....</b>	<b>32</b>
	5.1 Summary of results, geotechnical expert group .....	32
	5.2 Input to structural assessment.....	34
<b>6</b>	<b>Condition assessment .....</b>	<b>35</b>
	6.1 Introduction .....	35
	6.2 Compressive strength.....	36
	6.3 Top slab .....	37
	6.3.1 <i>Outer part</i> .....	37
	6.3.2 <i>Inner part</i> .....	38
	6.3.2.1 <i>Interface/cohesion assessment</i> .....	39
	6.3.2.2 <i>Chloride content</i> .....	39

6.3.2.3	<i>Water content</i> .....	40
6.3.2.4	<i>Corrosion (current level/risk of future corrosion)</i> .....	40
6.3.3	<i>Fire protection</i> .....	41
6.4	<i>Outer walls</i> .....	42
6.4.1	<i>HCP measurements and break outs</i> .....	42
6.4.2	<i>Chloride content</i> .....	42
6.4.3	<i>Water content</i> .....	42
6.5	<i>Mid wall</i> .....	43
6.5.1	<i>HCP measurements and break outs</i> .....	43
6.5.2	<i>General condition</i> .....	43
6.6	<i>Bottom slab</i> .....	43
6.6.1	<i>Post tensioning cables</i> .....	43
6.6.2	<i>Chloride content</i> .....	44
6.7	<i>Immersion joints and closure joint</i> .....	44
6.8	<i>Conclusions</i> .....	46
<b>7</b>	<b>Structural assessment</b> .....	<b>48</b>
7.1	<i>Introduction</i> .....	48
7.2	<i>Purpose</i> .....	48
7.3	<i>Safety, loads combinations, loads and material strengths</i> .....	48
7.3.1	<i>Accidental actions</i> .....	49
7.3.1.1	<i>Fire</i> .....	49
7.3.1.2	<i>Ship impact scenarios</i> .....	49
7.3.1.3	<i>Flooded tunnel</i> .....	50
7.4	<i>Longitudinal analyses</i> .....	50
7.4.1	<i>Introduction</i> .....	50
7.4.2	<i>Structural system</i> .....	50
7.4.3	<i>FE-models</i> .....	50
7.4.3.1	<i>Geometry</i> .....	51
7.4.3.2	<i>Sectional properties</i> .....	51
7.4.3.3	<i>Support conditions</i> .....	51
7.4.3.4	<i>Loads</i> .....	51
7.4.4	<i>Results, sectional forces and stresses</i> .....	52
7.4.4.1	<i>Model 1, 2-D shell model</i> .....	52
7.4.4.2	<i>Model 2, 3-D model</i> .....	54
7.4.4.3	<i>Model 3, 2-D beam model</i> .....	54
7.4.5	<i>Sensitivity analyses</i> .....	54
7.4.6	<i>Capacity verifications</i> .....	54
7.4.6.1	<i>Bending moment capacity</i> .....	55
7.4.6.2	<i>Shear capacity, global shear</i> .....	56
7.4.6.3	<i>Shear in construction joints</i> .....	56
7.4.6.4	<i>Bearings</i> .....	57
7.4.6.5	<i>Piles</i> .....	58
7.4.7	<i>Flooded tunnel</i> .....	58
7.4.8	<i>Summary of utilization ratios, longitudinal direction</i> .....	58

	7.5	Transverse analyses.....	59
	7.5.1	Introduction.....	59
	7.5.2	Analyses of transverse Properties.....	59
	7.5.2.1	Geometry and sectional properties.....	60
	7.5.2.2	Support conditions.....	60
	7.5.2.3	Results.....	61
	7.5.3	Capacity verification.....	62
	7.5.3.1	Properties.....	62
	7.5.3.2	Results.....	62
	7.5.4	Non-linear analyses by FEM software.....	63
	7.5.4.1	Assumptions.....	64
	7.5.4.2	Results.....	64
	7.5.5	Assessment of interface between original and repair concrete of the roof.....	66
	7.5.5.1	Shear capacity according to section 6.2.5 in DS/EN 1992-1-1 including DK NA.....	66
	7.5.5.2	Shear capacity according to section 6.3.4 in FIB Model Code 2010.....	68
	7.5.5.3	Interface/cohesion assessment.....	68
	7.5.5.4	Condition assessment.....	68
	7.6	Conclusions.....	69
	7.6.1	Longitudinal direction.....	69
	7.6.2	Transverse direction.....	69
<b>8</b>		<b>Basic Maintenance and Repair Strategy.....</b>	<b>70</b>
	8.1	Introduction.....	70
	8.2	Actions recommended.....	70
	8.3	Inspection and monitoring.....	71
	8.4	Preventive maintenance and repair.....	73
	8.5	Trigger values.....	73
	8.5.1	Total settlements.....	73
	8.5.2	Differential settlements.....	74
	8.5.3	Condition monitoring.....	75
	8.5.4	Key parameters and trigger values - Overview.....	75
	8.6	Expected repair activities until 2069.....	77
	8.7	Conclusions.....	78
<b>9</b>		<b>Retrofitting strategies.....</b>	<b>79</b>
	9.1	Methodology.....	79
	9.2	Geotechnical strategies.....	79
	9.2.1	Purpose.....	79
	9.2.2	Optioneering process.....	79
	9.2.3	Preferred Geotechnical Option: Active horizontal compensation grouting.....	80
	9.3	Structural strategies.....	83
	9.3.1	Purpose.....	83
	9.3.2	Additional prestressing.....	83
	9.3.3	Replace bearing blocks.....	86
<b>10</b>		<b>Costs.....</b>	<b>88</b>

10.1	Introduction .....	88
10.2	Retrofitting Budgets .....	90
10.3	50 years budget .....	90

# 1 Executive Summary

## **Objective**

The objective of the work carried out by the Structural Expert Group and summarized in this report has been to provide the Danish Road Directorate with suitable and practical guidance to maintain, repair and correct (where relevant) the structures of the Limfjord Tunnel for the remaining lifetime of the tunnel until the year 2069.

## **Background**

The Limfjord Tunnel was completed in 1969 and it was soon realised that the water-proofing membrane of the tunnel was not functioning properly, as seawater was observed to be leaking through cracks in the tunnel roof and outer walls.

During the first 25 years of service, recorded settlements of the tunnel up to approximately 95 mm have significantly exceeded the originally predicted design settlements of 30 mm. During the same initial 25 year period the length of the tunnel has increased by up to 1 mm per year, this is due to the seasonal temperature variation experienced in the tunnel (resulting in cracks remaining permanently open).

Continued leaking of water into the tunnel in combination with the internal walls being exposed to de-icing salts has resulted in corrosion of the reinforcement at the internal face of the walls and roof slab.

Post-tensioning cables were installed below the pavement in the tunnel in 1993-94 with the purpose of closing the cracks and stopping water leakage. It has been found that the gradual increase of the tunnel length has stopped as a consequence of installing these cables. However, the post-tensioning cables were not able to eliminate water leakage and crack injections have been undertaken yearly to reduce the water leakage.

A major repair, where corroded reinforcement and concrete was removed up to a depth of 200mm and replaced with new reinforcement and concrete, was carried out in the tunnel ceiling in the late 1990's. This repair was subsequently strengthened with anchors in 2010 as delamination between the repair and original concrete took place sometime after the initial reinforcement/concrete replacement.

## **General Basis of Assessment**

The structural safety of the tunnel in the ultimate limit state (ULS) has been assessed in the two main load bearing directions, the longitudinal and transverse direction in accordance with the Eurocodes. The governing loads include self-weight of the tunnel, back fill, erosion protection, sedimentation, settlement, water pressure, pre-stressing and temperature.

It has been previously assessed that the large settlements of the tunnel are mainly due to creep settlement within the sand fill below the tunnel.

**Structural Assessment – Longitudinal Direction**

The behaviour of the tunnel in the serviceability limit state (SLS) has been assessed to verify stresses and crack widths and to check if an explanation can be given to why leakage is still observed in the tunnel after the 1993-94 installation of the post-tensioning cables.

The analyses for the SLS case have indicated that there are tensile stresses in the longitudinal direction in the top and bottom slab resulting from the settlement recorded in the year 2017. The 1993-04 post-tensioning project has therefore not been successfully in fully closing the existing cracks and keeping the tunnel structure in compression. For the load case with the predicted future increase in settlement in the year 2069, the tensile stresses will increase further. It is therefore expected that water leakage and the requirement for the injection of leaking cracks will continue if no other measures are taken.

The global bending moment and shear capacity for the ULS case in the longitudinal direction have been evaluated together with ULS shear capacity at the vertical construction joints in the tunnel. In addition, the ULS capacity of the bearings and piles at the northern end of the tunnel has been evaluated. The evaluation analyses have been carried out for both the predicted future settlement during the next 50 years and for an additional 50%. The capacity evaluation has in general shown that the tunnel has adequate structural capacity in the longitudinal direction with satisfactory margins to carry the increased stresses induced by the predicted future settlements.

The structural capacity of the tunnel has also been preliminary checked for the accidental load with a water filled tunnel. The tunnel is expected to survive this accidental load with some damage, which will need to be assessed and repaired after removal of the water.

**Structural Assessment – Transverse Direction**

It has been verified through a simple a 2D frame model that the tunnel has adequate ULS bending moment capacity and that crack widths in general are below the maximum allowable crack width for loads carried in the transverse direction.

A more advanced method has been used to analyse the overall combined ULS shear and bending moment capacity in the transverse direction as it was not possible to verify ULS shear capacity with the simple 2D frame model. This approach follows explicitly the crack development until a total collapse of the tunnel is found at a given load. The results of the analysis have concluded that for the ULS case the structural capacity is satisfactory for the tunnel structure in the transverse direction.

The structural capacity of the interface shear between the repair and the original concrete has been reassessed as being satisfactory. This was used as the basis to the structural assessment of the tunnel cross section in the transverse direction.

**Structural Assessment – Overall Conclusion**

Structural analyses have revealed that the ULS capacity of the tunnel complies with existing standards for the settlements experienced up to 2017, for the predicted settlements to 2069 and even for a scenario with an additional settlement allowance. It is therefore considered very unlikely that the tunnel will exceed the ULS case in the next 50 years.

### **Structural Assessment – Accidental ship Loads**

Accidental loads related to shipping traffic that may affect the tunnel have been considered at a preliminary/conceptual level. A preliminary risk assessment has been carried out considering possible loads related to ships (i.e. sunken ship resting on the tunnel roof, grounding ship impact, dragged anchor engaging the tunnel sides and a dropped anchor on the tunnel roof). This assessment has verified that the annual frequency of accidental actions that may cause damage severe enough to threaten life safety is in accordance with the applicable standards with the exception of a grounding ship impact at the northern end of the tunnel. It is recommended that a more detailed investigation of the grounding ship impact load scenario is carried out to assess if protective measures will be required.

### **Condition Assessment**

A comprehensive physical condition assessment of the tunnel structure has also been carried out. The main conclusions are summarised below:

- The characteristic compressive strength of the concrete has been determined to be a minimum of 40 MPa compared to the original requirement of 25 MPa.
- The outer waterproofing membrane is found to have limited function and is unable to prevent water ingress into the concrete structures.
- Numerous cases of leaking water have been observed in core holes and break outs indicating that the tunnel structures are heavily exposed to water ingress.
- High chloride contents have been found in several samples. In other samples very low chloride contents have been determined.
- No signs of significant corrosion of reinforcement have been observed during inspections. Hence, it is considered that the reinforcement is generally in good condition.
- The quality of the interface between the repair and the original concrete in the roof is assessed to be adequate to effectively transfer the shear forces although delamination is seen in some areas.
- It is strongly recommended to keep the tunnel under increased observation by comprehensive monitoring and inspection activities due to the high exposure to water ingress and significant chloride contents seen in some areas of the tunnel.

### **Basic Maintenance and Repair Strategy**

Major repairs of the tunnel are not considered to be necessary within the next 10-15 years if the monitoring and maintenance plan, which has been established is followed. The suggested monitoring plan includes the logging of key parameters to ensure that adequate information will be provided of the tunnel behaviour in advance of it possibly exceeding the limits identified in the report without warning. Remedial actions have been identified which could be implemented if the tunnel behaviour exceeds the specified limits.

### **Retrofitting Projects**

The remedial actions include one geotechnical and two structural retrofitting projects.

The geotechnical retrofitting strategy comprises horizontal compensation grouting under the tunnel structure. By adopting this method, it will be possible to provide controlled uplift of the tunnel and thereby counteract future settlements. The compensation grouting operations will be undertaken from cofferdams located outside the tunnel structure in the Limfjord and it can be undertaken without impacting the operation of the tunnel.



The preferred structural retrofitting project includes additional pre-stressing with the purpose to close cracks and limit water leakage through the tunnel structure. The pre-stressing will be placed within the structural clearance profile and outside the traffic clearance profile along the upper parts of the walls.

The alternative structural retrofitting project comprises replacing and lowering of the bearing blocks at the northern end of the tunnel. This could potentially reduce the future settlements and reduce tensile stresses / water leakage in the tunnel.

**Costs**

A 50-year budget has been developed which includes an allowance for the three identified retrofitting projects

## 2 Background and objectives

### 2.1 Introduction

The existing tunnel link between Aalborg and Nørresundby, shown on [Figure 2.1-1](#), is a highway tunnel crossing below Limfjorden with water depths ranging from 1 to 12 m along the tunnel line. The immersed tunnel is a monolithic reinforced concrete structure that was constructed during the 1960's and it was opened for traffic by May the 6<sup>th</sup>, 1969. A more detailed description of the tunnel is included in Section 4.



**Figure 2.1-1** Aerial view and location plan considering the tunnel between Aalborg and Nørresundby.

From the very beginning the tunnel was suffering leakages, especially in the middle section of the tunnel. The most probable reasons have been studied in earlier assessments and identified as primarily due to the malfunctioning of the waterproofing membrane, observed from the very beginning. The concrete structure has not been designed / detailed to be watertight and crack width requirements may not be met for watertight structures. Additionally, restrained axial deformations (in longitudinal direction), as well as settlements have resulted in tensile stresses leading to cracks in the concrete that further contributed to the leakages. Some repair campaigns have been undertaken (Section 4.5) but these did not provide the ultimate solution of stopping the leakages. Annual injection campaigns are an ongoing requirement to manage the leakage issue. From a durability and operational point of view this has becoming an increasing concern for the Danish Road Directorate.

Additionally, continued settlements of the tunnel have been observed since 1969, in the northern section of the immersed tunnel reaching as much as 130 mm, which can be considered as substantial (Section 4.6). This has given another reason for concern for the Danish Road Directorate.

To clarify the expected remaining lifetime of the tunnel, the Danish Road Directorate established a Geotechnical Expert Group and a Structural Expert Group, to further analyse the issues described above.

The Geotechnical Expert Group acted in the period of May 2017 to April 2018 under the mandate of identifying the reasons for the observed settlements and predicting additional settlements until 2069 corresponding to 100 years after tunnel opening. Creep of the uncompacted sand fill below tunnel elements IV and V was found to be the main contributor to the continued settlements and additional settlements of up to 60 mm from 2017 to 2069 was predicted. The Structural Expert Group worked under the mandate of:

- Describe a long-term maintenance plan and outline one or more retrofitting project(s).
- The retrofitting project(s) shall be described both technically and economically, and the influence on traffic flow/capacity during the implementation of the project(s) shall be evaluated.

The objective of the work of the Structural Expert Group, summarized in the underlying report, is to provide the Danish Road Directorate with suitable and practical guidance as to maintain and repair (where relevant) the structures of the Limfjord Tunnel for the remaining lifetime of the tunnel to year 2069. The Structural Expert Group has therefore provided:

- A maintenance plan that identifies suggested surveys of the tunnel (when to measure what).
- Trigger values that link the measurements from the maintenance plan to possible actions that should be initiated to mitigate if the measurements reveal an unexpected behaviour.
- An unexpected behaviour may cause repair / retrofitting projects to be considered.

The summary report and the background documents will allow the Danish Road Directorate to select a cost-efficient strategy depending on the future development of the various scenarios.

The assumptions and conclusions from the underlying summary report and the background reports are supported by all members of the Structural Expert Group.

The Structural Expert Group comprises:

Michael Gavins (Atkins)  
Michael Tonnesen (COWI)  
Carsten Schjørring (Christensen & Essenbæk)  
Nhut Nguyen (Delta Marine Consultant)  
Niels Mortensen (nmGeo)  
Hans Henrik Ebsen Christensen (Rambøll)  
Lars Knud Lundberg (Rambøll)  
Hans de Wit (TEC)

The group was supported by:

Dorthe Lund Ravn (COWI)  
Finn Raun Gottfredsen (COWI)  
Peter Møller (Rambøll)

## 2.2 Methodology

The Structural Expert Group started their work in May 2018 with a meeting in which the Danish Road Directorate explained the group's tasks and objectives and the Geotechnical Expert Group explained the main findings of their work.

A brainstorm meeting on how to organize the work of the Structural Expert Group was carried after a visit to the Limfjord Tunnel in June 2018. The work was organized into two subgroups, 1) A geotechnical sub group with focus on the geotechnical assessment and geotechnical input to the structural assessment and 2) A structural subgroup with focus on the structural assessment and the condition assessment. This is illustrated in a work organization flow chart in [Figure 2.2-1](#).

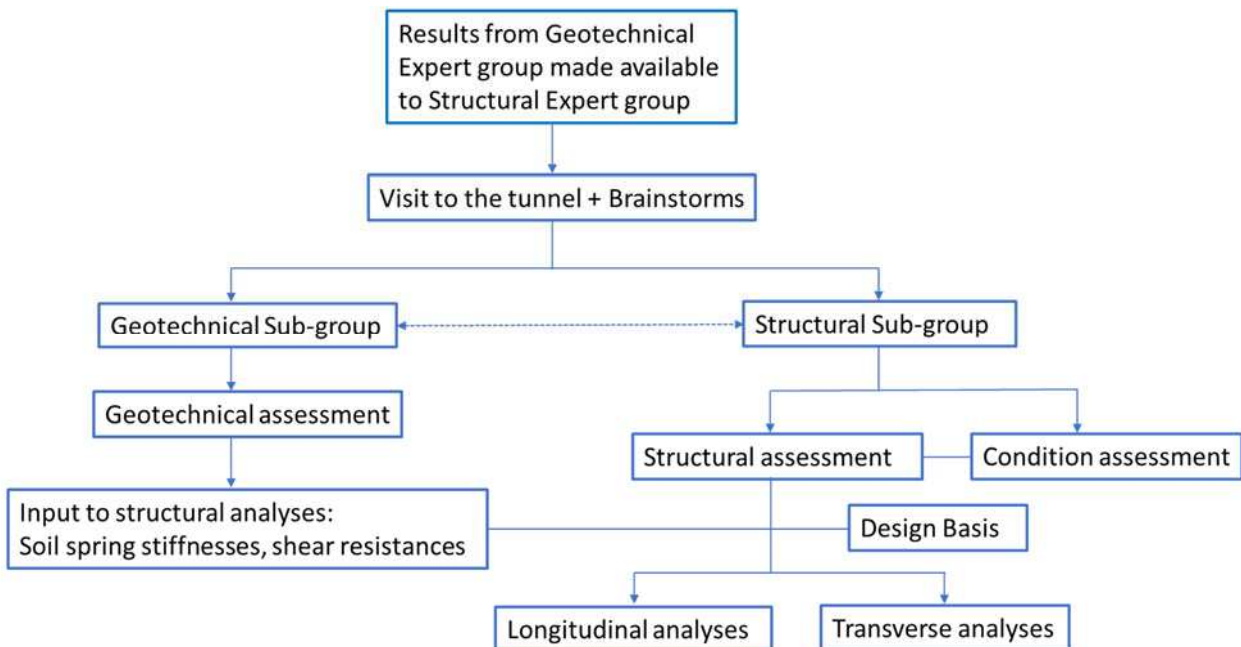

Figure 2.2-1 Work organization flow chart

The interaction between the geotechnical, structural and condition assessment is shown in the decision flow chart in [Figure 2.2-2](#).

The work started with review of relevant project information including as built documents and various previous condition assessments and data reports. Indicative structural analyses were initiated with the purpose to get an overview and to identify potential critical areas, which will serve as one of the focus areas of the condition assessment.

The identified critical areas were analysed in detail with input from the condition assessment. The outcome of the detailed analysis and further detailing of the indicative analysis plus results from the condition assessment provided the basis for the Basic Maintenance and Repair Strategy and for the identification of geotechnical and structural retrofitting options.

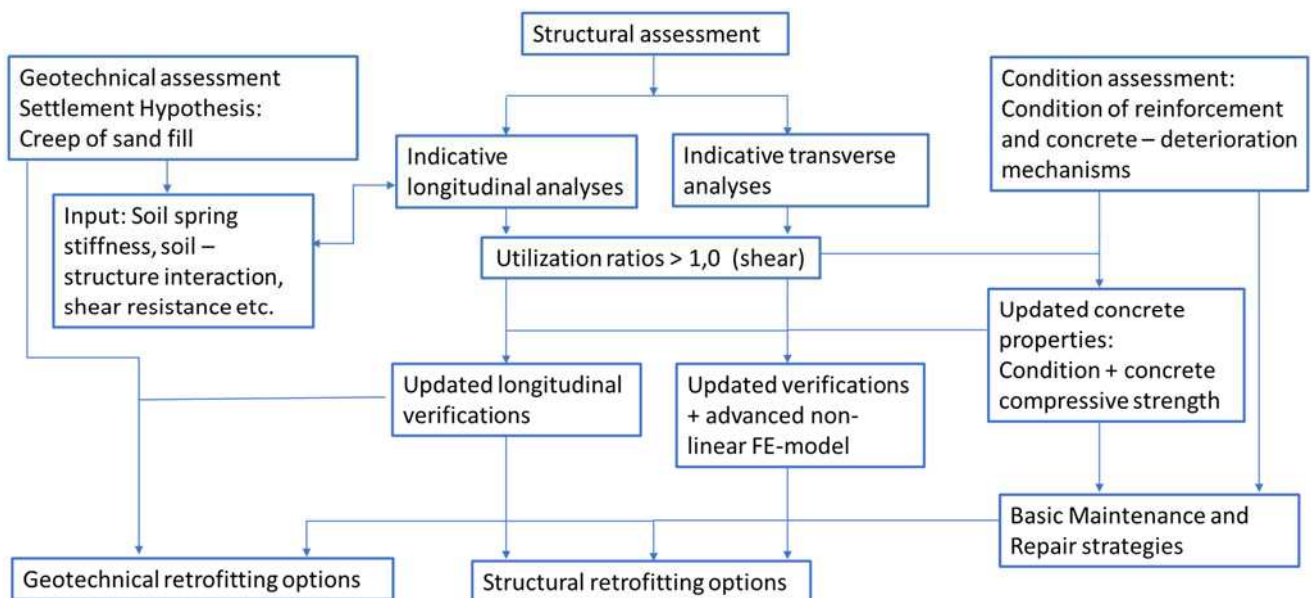

Figure 2.2-2 Decision flow chart

# 3 References

## 3.1 Normative references

- [1] Eurocodes including Danish national annexes (DK NA)
- [2] Handbook, Design Guide for load and calculation basis for bridges (includes supplementary rules for existing structures), April 2015
- [3] FIB Model Code for Concrete Structures, 2010

## 3.2 Background documents

Background documents from The Structural Expert Group and Geotechnical Expert Group, which are used as basis for the Technical Summary Report are listed below.

### *Geotechnical Expert Group Reports:*

- [4] Geotechnical aspects considering settlements of the Limfjord tunnel. The Danish Road Directorate, May 2018

### *Structural Expert Group Reports:*

- [5] Geotechnical Summary Note, nmGeo-2019-07-Rev 2.1, 25-06-2019 (nmGeo)
- [6] Geotechnical Retrofitting Options – Final, TN02-Rev C, 25-06-2019 (Atkins)
- [7] Geotechnical Retrofitting – Compensation grouting solution, TN03, 25-06-2019 (Atkins)
- [8] Design Basis, Rev 2, 25-06-2019 (Rambøll)
- [9] Longitudinal indicative analyses including appendices, Ver 2, 25-06-2019 (Rambøll)
- [10] Structural Retrofitting Strategies – Pre-screening of Options, Description of selected Retrofitting Options, 25-06-2019 (Rambøll)
- [11] Longitudinal indicative analyses – Beam model, A110235-SAN-02-002-Ver 2, 25-06-2019 (COWI)
- [12] Limfjord tunnel transversal section forces, Analyses of Transverse Properties, BIC-10-R-00001-R.T.-Rev B, 25-06-2019 (BAM/TEC)
- [13] Assessment of transverse design of the Limfjord tunnel, EF1097/SvA/JV/R190024-Ver B, 18-06-2019 (TEC/BAM)
- [14] Non-Linear FEM analysis, EF1097/HDW/JV/R190034-Ver-2.1, 21-06-2019 (TEC)
- [15] Shear Capacity of Casting Joints in top slab, Calculation Report, A110235-SAN-01-010-Ver 2, 25-06-2019 (COWI)
- [16] Shear Capacity of Casting Joints in top slab, Summary Report, A110235-SAN-01-011-Ver 2, 25-06-2019 (COWI)
- [17] Ship Accidents Risk Analysis, A110235-SAN-05-002-Ver 2, 25-06-2019 (COWI)
- [18] Basic Maintenance and Repair Strategy, A110235-REP-02-002-Ver 1, 25-06-2019 (COWI)
- [19] Condition Assessment, A110235-REP-01-001-Ver 1, 25-06-2019 (COWI)

### *Other Reports:*

- [20] Risikoanalyse – Limfjordstunnel, 16/02058-26, 03-06-2019, (Danish Road Directorate)
- [21] Limfjordstunnelen – Trafikale Konsekvenser, 16/02058-25, 15-05-2019, (Danish Road Directorate)

[22] Vurdering af effect af brandbekæmpelse – Cost-benefit analyser FTUN/GTUN/LTUN – Rev 1, 31-12-2014 (Rambøll)

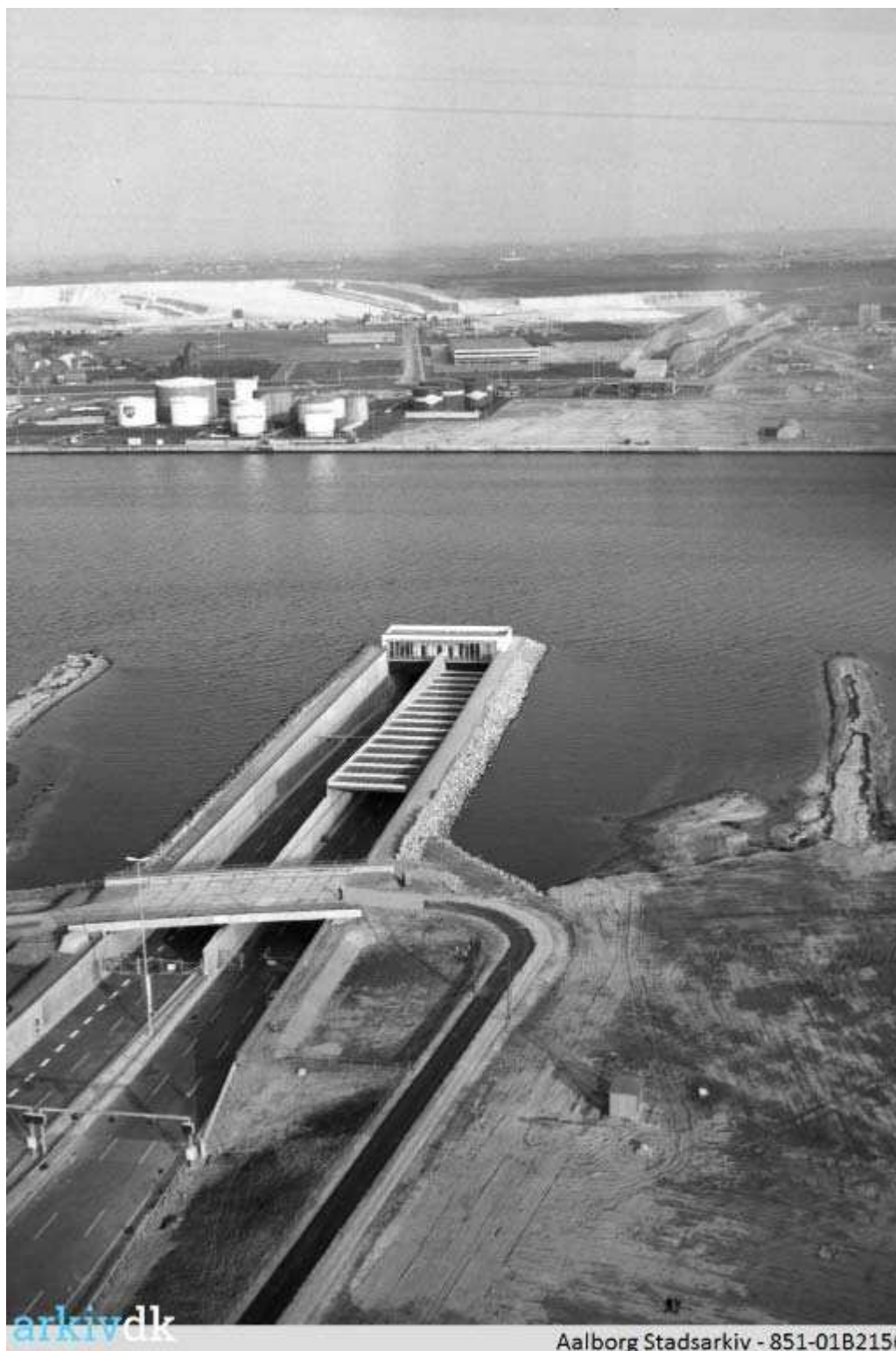

arkivdk

Aalborg Stadsarkiv - 851-01B2156



# 4 Description of tunnel

## 4.1 Structural layout

The tunnel was constructed in the late 1960's and opened to traffic in 1969. It has two tubes each 12 m wide and each with three lanes for vehicles.

The tunnel structures are in total 945 m and are divided in three main groups:

- The southern approach ramp (156 m), southern portal building (14 m) and cast-in-situ tunnel (43 m).
- The immersed tunnel consisting of five tunnel elements, I, II, III, IV and V each 102 m (total length 510 m).
- The northern approach ramp (207 m) and northern portal building (15 m).

The tunnel alignment is placed at a depth that allows a 139 m wide and 10 m deep navigation channel over a part of the immersed section of the tunnel. The southern portal building is located on land approximately 220 m behind the oil harbour quay wall, whereas the northern portal building is located in the fjord in a distance of approximately 150 m from the original coastline. The immersed tunnel is extending approximately 160 m under the harbour area behind the quay wall on the southern shore.

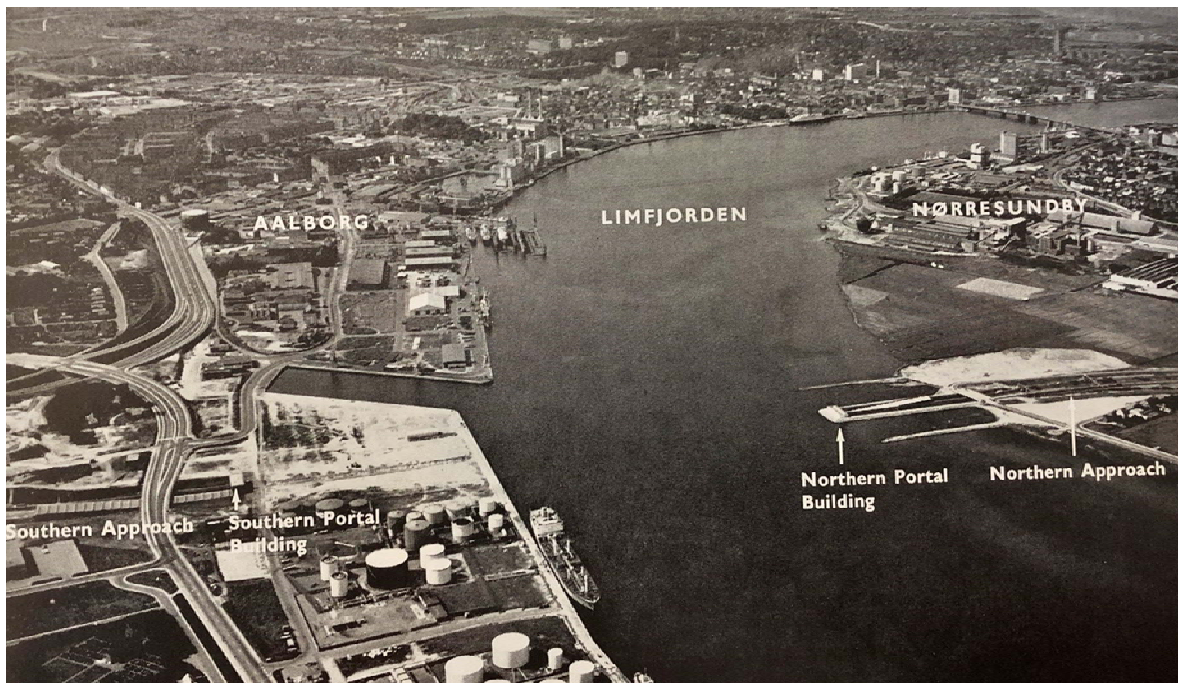

Figure 4.1-1 Areal photo of the Limfjord crossing.



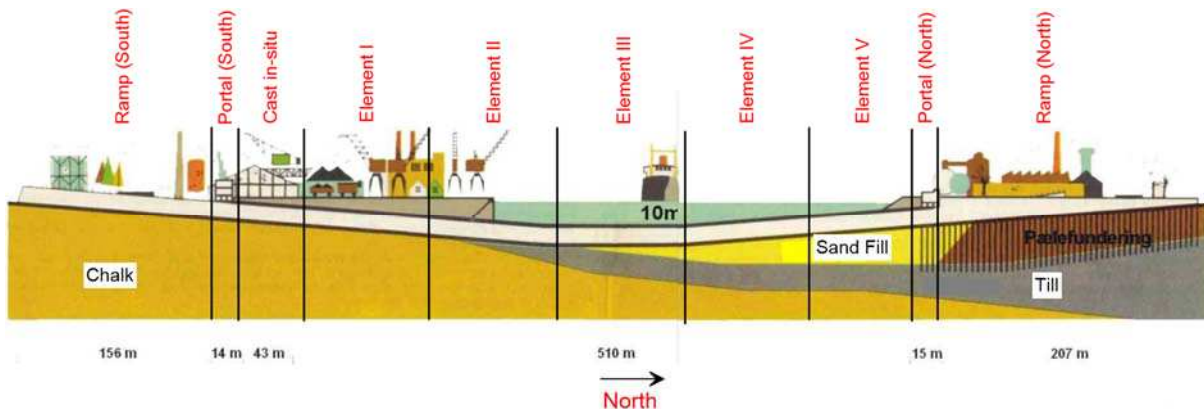

Figure 4.1-2 Longitudinal section of ramps, portal buildings, cast-in-situ tunnel and the five immersed tunnel elements.

The five tunnel elements are in the longitudinal direction straight as the curves of the vertical alignment of the road are formed in the ballast concrete placed after immersion.

The immersed tunnel and the cast-in-situ tunnel is one 553 m long monolithic reinforced concrete structure separated from the portal buildings by expansion joints. The tunnel is furnished with a 1 – 2 mm thick butyl membrane on the outside, which on top and bottom of the tunnel is protected by a layer of reinforced concrete.



Figure 4.1-3 Elastomeric bearing at the northern portal building.

The northern ramp and portal building are supported by piles, whereas all the other structures are directly founded on limestone, clay or sand fill. The northern end of the immersed tunnel is resting on elastomeric bearings carried by the northern portal building.

The safety against uplift for the immersed tunnel is minimum 1,05 considering the most unfavourable circumstances and without taking friction in the sand into account.

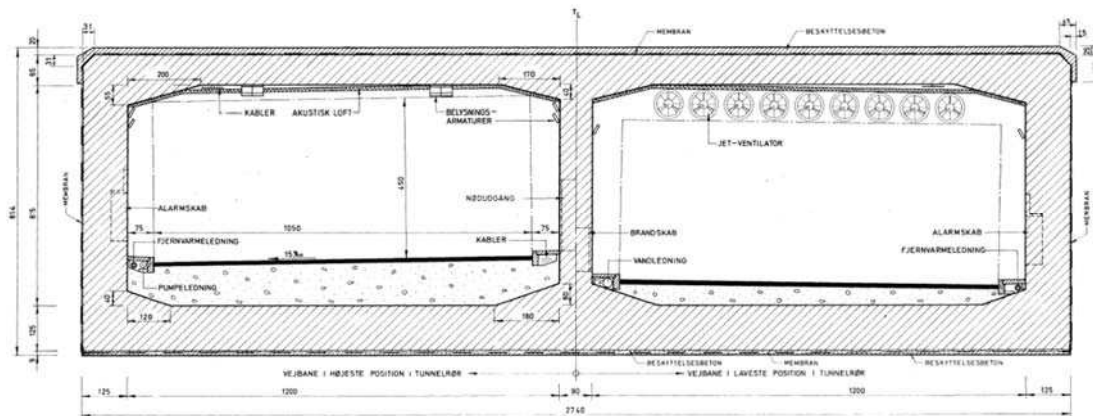

Figure 4.1-4 Typical cross section of tunnel under the fjord.

## 4.2 Soil conditions

The soil conditions in the area are characterised by limestone down to a significant depth. Above the limestone layer is a layer of clay till of varying thicknesses. To the south, the clay till layer is close to the terrain while to the north it is at a considerably lower level. The clay till layer in the area around the oil harbour quay wall is covered by a layer of late glacial Yoldia clay. On the remaining sections, the clay till layer is covered by meltwater sand above which is a layer of gyttja.

The southern ramp, southern portal building and cast-in-situ tunnel are constructed on a layer of gravel placed directly on the limestone.

The elements of the immersed tunnel are resting on an approximately 1 m thick layer of sand installed after immersion by use of the C&N sand jetting method. This sand layer is in the southern end resting on limestone or clay till and in the northern end on a sand filling with a thickness of up to 20 m installed after dredging and removal of the gyttja.

Tunnel element I and the southern half of element -II have their foundations directly on the limestone. From around the middle of element II near the oil harbour quay wall line and towards the north there is a sandy clay till layer above the limestone upon which the northern half of element II is placed. The thickness of this clay till layer is approximately 7 m.

At element III, a layer of Yoldia clay is situated above the clay till layer upon which the southern end of element III is placed. From the northern half of element III and all of the elements IV and V, the gyttja has been replaced with sand filling. The gyttja replacement has been continued to just north of the northern portal structure. The thickness of the sand filling layer increases from south to north from approximately 2 m to approximately 20 m.

The replacement of gyttja has been performed with a width equal to a slope  $a = 0,5$  from the edges of the underside of the tunnel. The dredging of the gyttja has been performed as a trench with slopes equal to  $a = 1,0 - 1,5$ . This is shown on [Figure 4.3-2](#).

## 4.3 Construction method

### 4.3.1 Earth works

The dry dock with space for casting the five tunnel elements was constructed approximately 10 km from the tunnel alignment. The bottom of the dock was at level -9,5 m and the groundwater level was lowered to execute a dry excavation.

The southern ramp, southern portal building and the cast-in-situ tunnel were constructed in a dry pit excavated behind the oil quay wall. The ground water level was temporarily lowered, but only until the execution of the wet dredging of the tunnel trench were taking place. On the northern shore the construction of ramp and portal building were executed in a dry pit created by construction of a dam and cut-off wall and groundwater lowering.



Figure 4.3-1 Dry pit at northern shore for casting of in-situ tunnel, portal building and ramp.

The wet excavation of the tunnel trench was executed with a bucket dredger. The slopes of the trench were approximately 1:1,3 and the maximum depth approximately level - 31 m. The gyttja under the northern section of the tunnel was dredged and replaced by an uncompacted sand filling executed by pumping the sand from a dredger through a pipe with an outlet under water. A pre-loading of the sand filling was created by placing a temporary approximately 2 m thick extra layer of sand above the actual filling. The thickness of 2 m refers to sand surface next to the tunnel.



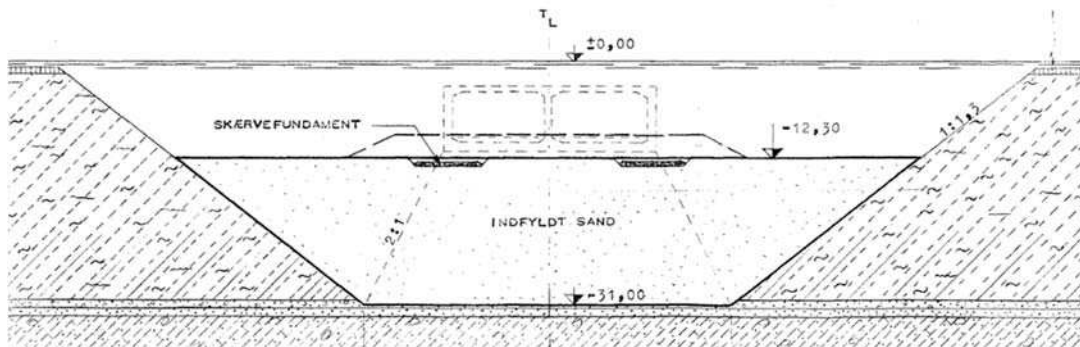

Figure 4.3-2 Cross section in tunnel trench where gyttja was replaced by a sand filling.

After installation of the tunnel elements the trench was backfilled with sand. In the fjord the sand on the sides of the tunnel was protected by a 1 m thick layer of stones.

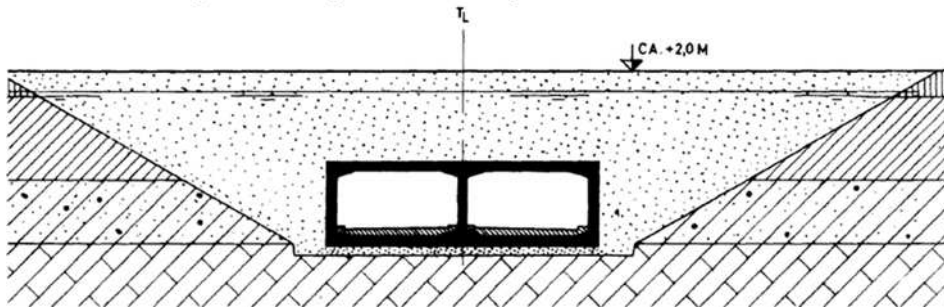

Figure 4.3-3 Cross section in tunnel trench, southern end (under quay area).

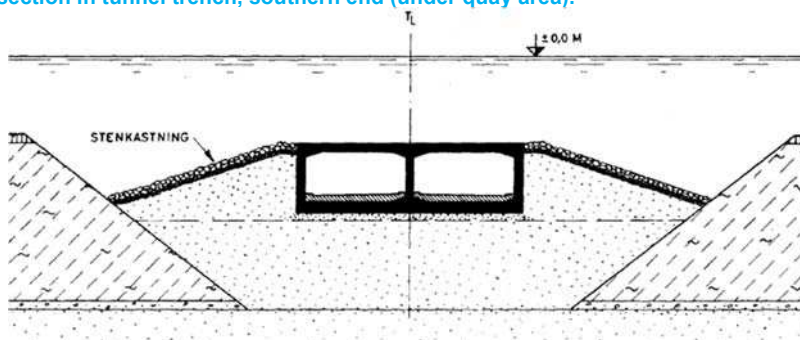

Figure 4.3-4 Cross section in tunnel trench under the fjord.

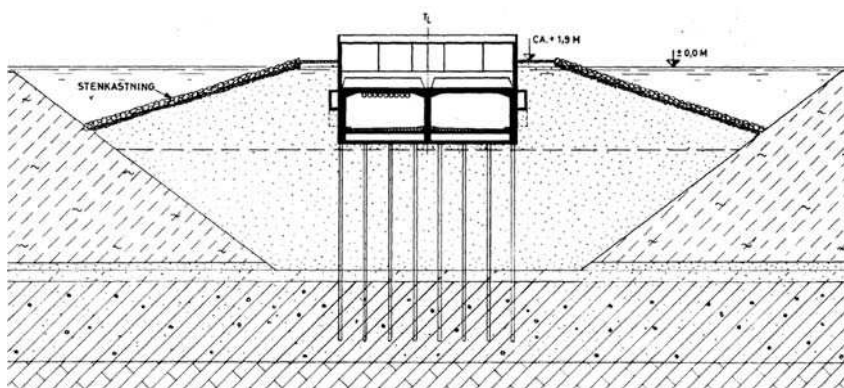

Figure 4.3-5 Cross section in tunnel trench at the northern portal building.

#### 4.3.2 Concrete works

The ramps, portal buildings and the cast-in-situ tunnel were constructed as traditional reinforced concrete structures; the ramps in sections with expansion joints at every approximately 14 m.

The five tunnel elements were cast in the dry dock in special casting sections arranged to attempt to compensate for the effects of shrinkage. The elements were cast in 12,8 m long sections; first the bottom slab, then the walls and finally the top slab. The period between castings was maximum 3 weeks. The sections were separated by 1,8 m long openings, which were cast as late as possible to achieve maximum shrinkage of the 12,8 m long sections.

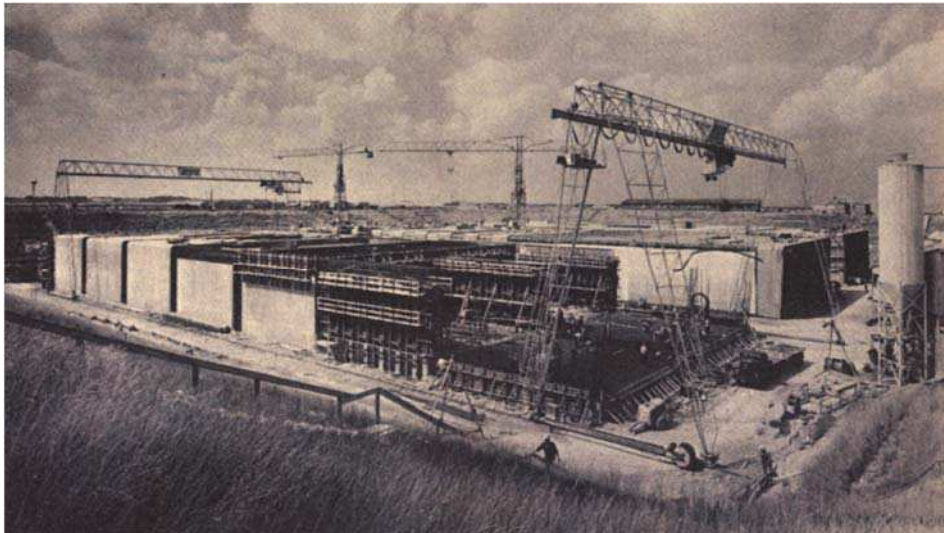

Figure 4.3-6 Casting of tunnel elements in the dry dock. The casting sections and openings can be seen on top picture.

Ten different types of concrete mixes were used in the various tunnel structures including concrete piles. The concrete mix for tunnel elements had a minimum average cylinder strength of more than 300 kg/cm<sup>2</sup> and the binder was standard Portland cement. The fine aggregates were natural sand and coarse aggregates were either crushed granites or sea materials.

Reinforcement was in general weldable rebars with a minimum yield strength of 4200 kg/cm<sup>2</sup>. The maximum crack width was not allowed to exceed 0,25 mm.

#### **4.3.3 Installation of elements**

Each tunnel element had at both ends a steel end frame extending along the entire outer perimeter. On the steel end frame at the south end a Gina type rubber gasket was attached.

After outfitting of the elements in the dry dock with water ballasting tanks and pump systems, bulkheads, bollards, access shaft and the rubber gasket, the dock was flooded. The tunnel elements were ballasted to remain on the bottom of the dock during and after the flooding.

At the same time as the last section of the tunnel trench was excavated, a channel into the dry dock was dredged. The tunnel elements were then one by one floated and transported by use of tug boats the approximately 10 km distance from dry dock to the tunnel alignment. At the tunnel site they were prepared and equipped for the immersion operation. Two catamaran immersion pontoons were used for the immersion. The elements were installed one by one from south towards north.

After immersion the tunnel elements were temporarily supported in three points. One support was created by a console extending from the middle wall resting on the adjacent element/structure to the south. The two other supports were arranged on temporary gravel pad foundations at the northern end of the element. The correct vertical alignment was secured by use of jacks installed at all the temporary supports.

Watertight immersion joints were initially established by the rubber gasket attached to the south end of each tunnel element. As soon as the space between the two bulkheads of the elements to be connected was drained the rubber gasket was compressed between the end frames of the two adjacent elements.



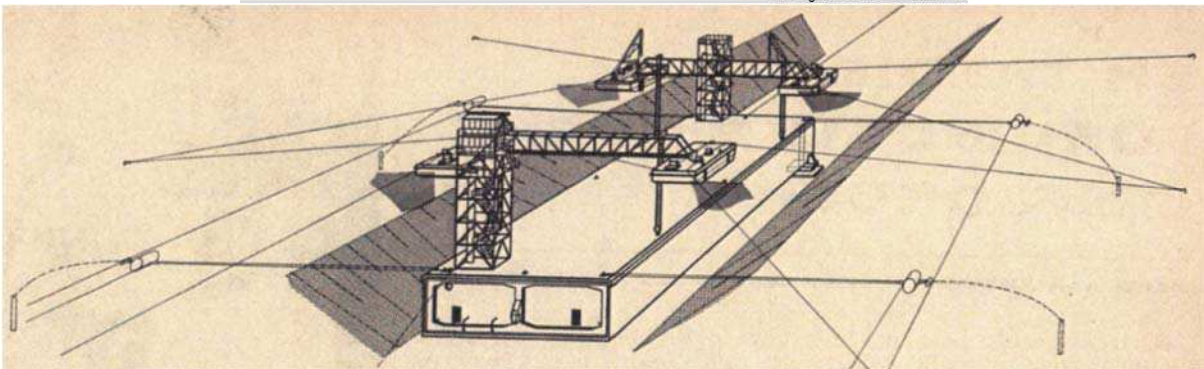

Figure 4.3-7 Immersion of tunnel element onto temporary supports.

#### 4.3.4 Joints

A secondary watertight seal was installed on the inside of the primary Gina type gasket. This seal was a flat rubber seal bolted to the end frames of the elements.

On the inside of gasket and seal recesses were made to allow the casting together of the elements. The rebars were connected by installation of additional pieces of rebars butt welded to the rebars extending from both elements.

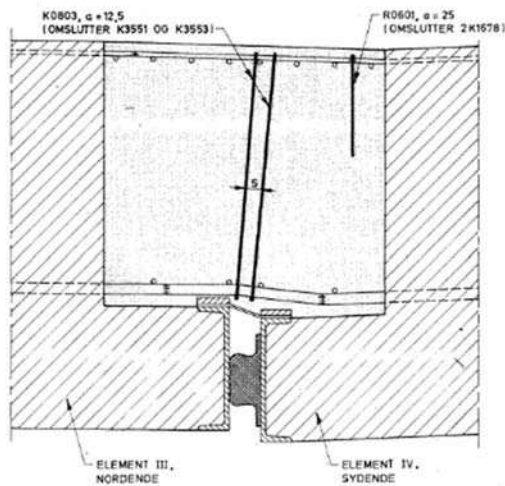

Figure 4.3-8 Immersion joint. The joint shown is between elements III and IV where additional reinforcement was installed due to the not perfect alignment.

This type of joint was used to connect the cast-in-situ tunnel with element I and to connect elements I, II, III, IV and V. Between the element V and the south end section of the northern portal building a closure joint was cast inside a temporary watertight enclosure.

The joints created a monolithic tunnel structure from the cast-in-situ tunnel to the northern portal building. Available information indicate that the immersion joints have all been successful as in general no water leakages have been reported in connection to the joints.

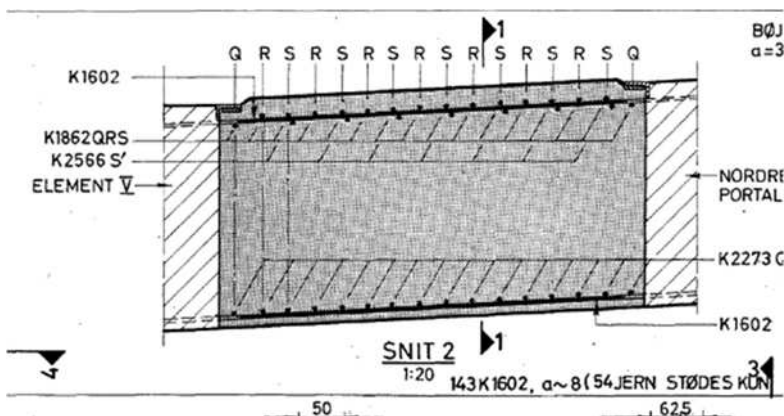

Figure 4.3-9 Closure joint. Located between Element V and south end section of the northern portal building



#### 4.3.5 Waterproofing membrane

The 1 – 2 mm thick butyl membrane was installed on the outer surface of the tunnel structures to ensure the watertightness of the tunnel.

On the bottom and top of the tunnel elements the membrane was protected by a layer of reinforced concrete.

In the fjord the protection on the top is approximately 200 mm thick and in the quay area to the south approximately 50 mm thick. In the entire area the protection with reinforced concrete at the bottom is approximately 60 mm thick. Before installation of the reinforcement for the tunnel bottom slab a 30 mm thick layer of unreinforced concrete was placed on top of the membrane as a protection from the rebar works.

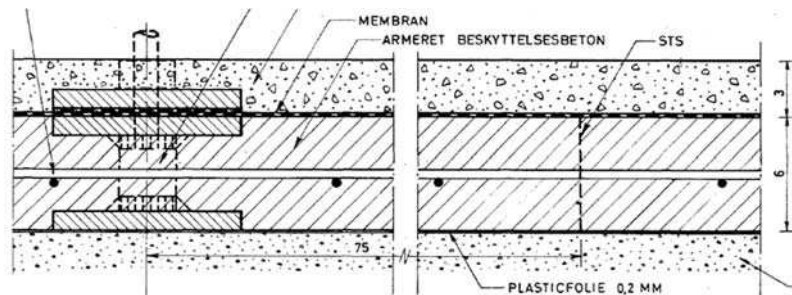
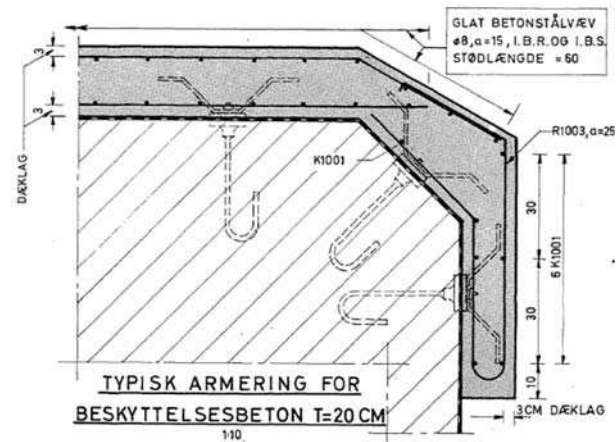

Figure 4.3-10 Protection of membrane at the bottom of tunnel elements (Dimensions are shown in cm).

On the sides of the tunnel elements there was no protection and available information indicates that already during transport and immersion some damages occurred on the unprotected membranes on tunnel sides. Further it has been indicated that the adhesion of the membrane to the structures was not perfect.

It is a fact that the membrane failed to create the watertight structure as was intended.



Aalborg Stadsarkiv - 851-01B21327

Figure 4.3-11 Protection of membrane at the top side including the top corner of tunnel elements (Dimensions are shown in cm).

## 4.4 Early defects

### 4.4.1 Leakage

Leakages were observed already immediately after installation of elements. The leakages continued to occur also during the start of operation.

As the damages on the membrane during transport and immersion were assumed to be the main reason for the leakages, attempts were made to repair these damages before the backfill made such repairs impossible. Available information indicates that the repairs executed by divers and under water were not successful.

The leakages occurred mainly in or around the 1,8 m wide openings cast after the 12,8 m wide main sections. They were also concentrated in the top slab sections of elements II, III and IV.

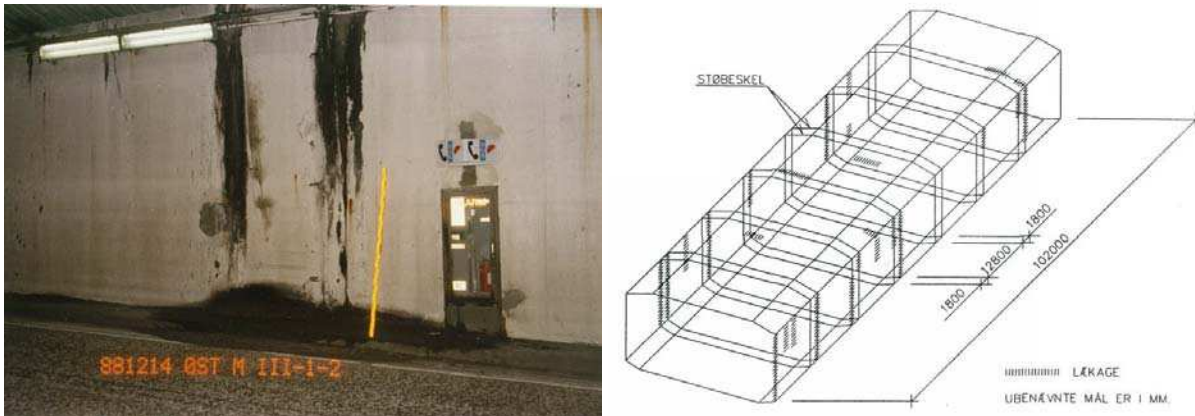

Figure 4.4-1 Water Leakage at the short sections (Dimensions are shown in mm)

The leakage was observed through already existing early-age and shrinkage cracks in the tunnel roof and outer walls.

The situation that the tunnel was not watertight had an impact on the operation, as the leakage water was apparent to the users, creating some (not relevant) anxiety regarding the safety of the tunnel and some practical problems due to the sometimes, heavy inflow of water.

Further the comprehensive occurrence of leakages caused the concern that they would influence the durability of the tunnel, i.e. shorten the operational lifetime of the structure.

#### 4.4.2 Settlement and deformation monitoring

The settlements of the tunnel elements were measured and recorded on a regular basis and these settlements were considerably bigger than the maximum few cm foreseen in the original design.

Further the yearly movements at the expansion joints of both ends of the monolithic tunnel due to the seasonal temperature variations have been monitored and recorded. The movements have not been completely cyclic as the structure has increased its lengths with small increments over time.

### 4.5 Repair and strengthening works

#### 4.5.1 Background

The high rate of the settlements not foreseen in the design continued over the years and showed almost no signs of decreasing.

The many and continuing leakages of salt water from the fjord through the outer walls and top slab of the tunnel and the significant exposure of the inside surfaces of the tunnel to salt water sprays from de-icing salts on the roads, caused reinforcement corrosion and resulted in a need for comprehensive

concrete repair works after a period of 25 – 30 years. Example of reinforcement corrosion as recorded from an inspection in 1988 is shown on [Figure 4.5-1](#).



**Figure 4.5-1 Reinforcement corrosion from inspection in 1988.**

Already at that time – with a traffic intensity much lower than today – it created a difficult traffic situation when the necessary concrete repair works closed a tunnel tube during a year and all traffic had to be ducted through the one remaining tube.

It was concluded that the problems were caused by the combination of a defect membrane, temperature variations in the monolithic structure, the unexpected big settlement rates and other circumstances regarding support conditions. Investigations were made, and proposals developed regarding how to compensate or eliminate the negative circumstances.

As result of these investigations it was decided to strengthen the tunnel structure to reduce or eliminate the cracking – and thereby reduce or stop the leakages and at the same time improve the carrying capacity in the longitudinal direction.

#### **4.5.2 Activities (1990 – 2018)**

The following major repair and strengthening projects were executed:

- Tensioning of the tunnel cross section with cables installed in the ballast concrete: 1993 – 1994.
- Repairs of sections of ceiling and walls and installation of tiles on walls: 1995 – 1998.
- Fire protection of structures: 1998 – 1999.
- Fixing of delaminated concrete with adhesive anchors: 2010 – 2011.
- Replacement of parts of ballast concrete and wearing course: 2012.
- Crack injections: Continuously (detailed records from the period 2008 – 2018).
- Repairs in northern joint chamber: 2007 and later.

In addition to above activities mainly covering the immersed section of tunnel there have been executed repairs on remaining structures such as the ramps.



The tensioning of the tunnel with post tensioning cables installed in the ballast concrete in 1993-94 was carried out with the purpose to reduce the longitudinal tensile stresses and close through going cracks and thereby limit/stop water leakage. The Ultimate Limit State (ULS) structural capacity in the longitudinal direction was increased due to the additional post tensioning cables and thereby increasing the robustness of the tunnel. The location of the post tensioning cables is shown on [Figure 4.5-2](#).

The deformations of the tunnel due to the seasonal temperature variations resulted, before the tensioning of the tunnel cross section, in a slow increase of the tunnel length corresponding to approximately 1 mm per year. After the installation of the cables in 1993 – 1994 the yearly increase in length has in general been stopped.

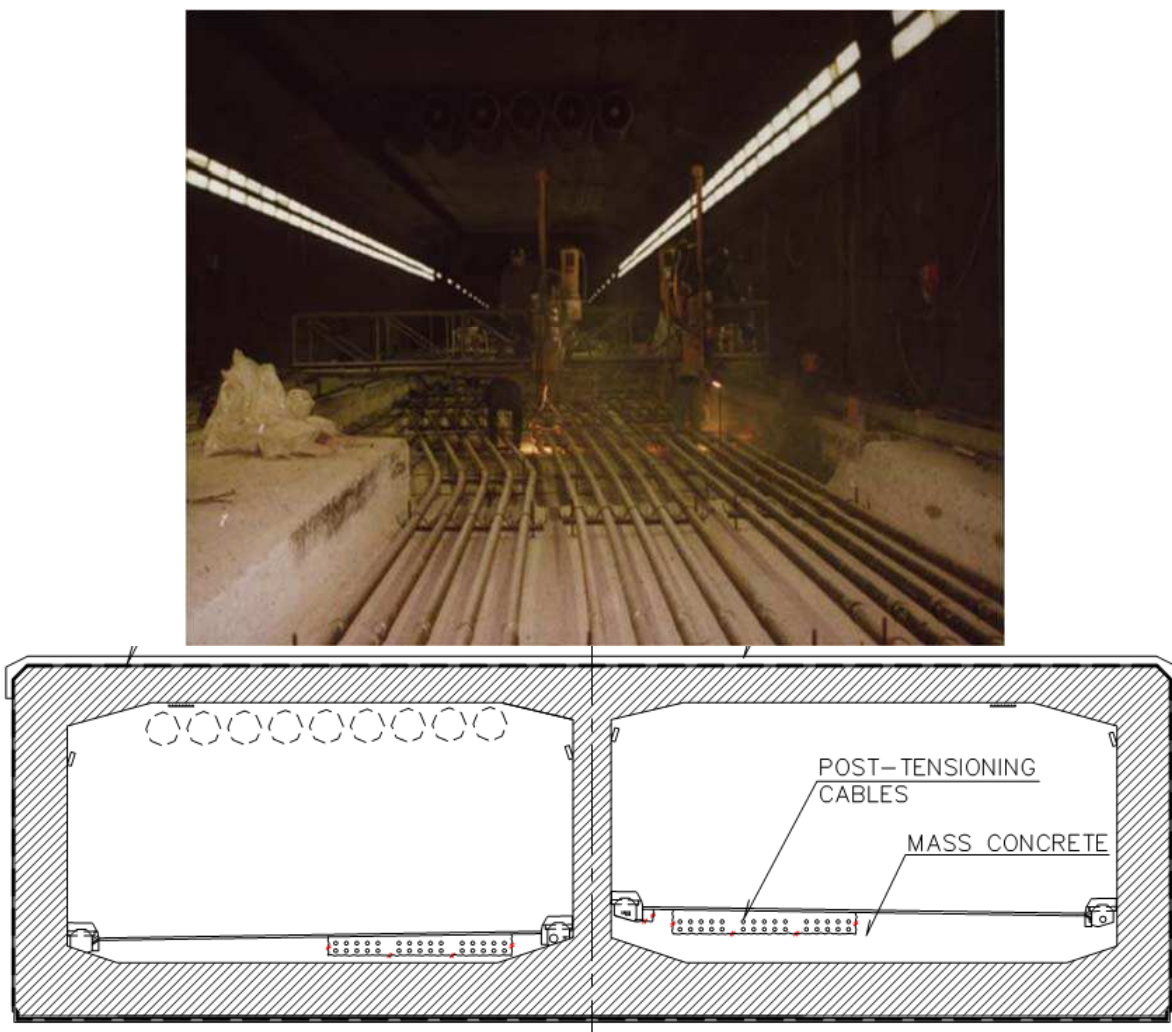

**Figure 4.5-2 Typical cross section with post tensioning cables installed in ballast concrete in 1993 – 1994.**

A large part of the 1998 repaired concrete in the tunnel ceiling was retrofitted in 2010 - 2011 with adhesive anchors between the repair and original concrete as delamination was observed between the repair and original concrete. This retrofitting inclusive a reassessment of the structural capacity of the repaired section is described in Section 7.5.5.

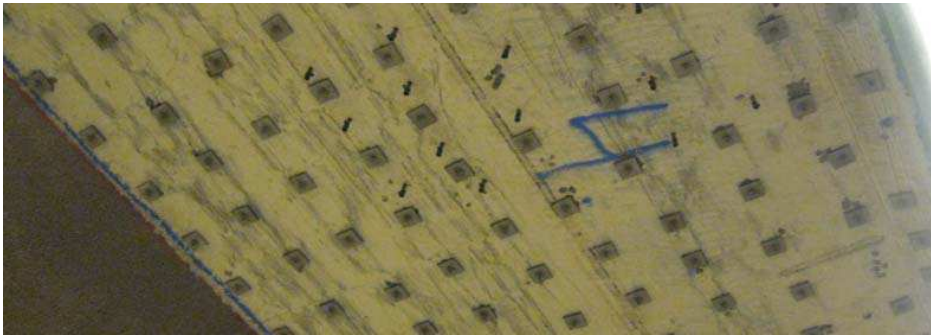

Figure 4.5-3 Installation of adhesive anchors in tunnel ceiling to make a structural connection between repair concrete and original concrete

### 4.5.3 Current activities

Since the above listed repair and strengthening activities the monitoring and maintenance of the tunnel has been less intensive.

#### 4.5.3.1 Crack injection campaigns

Cracks and leakages occur every year when the temperature drops and the tunnel structure contracts.

Crack injection campaigns are therefore executed every winter on almost regular basis. The crack injections are possible during late evenings and nights when one tunnel tube can be closed for traffic without creating serious restrictions for the traffic. The impact on the flow of traffic is minimal as the tunnel can be kept completely open during daytime and rush hours.



Figure 4.5-4 Injection of leaking cracks

#### 4.5.3.2 Other activities

As in case of the crack injections other maintenance works – e.g. on E & M equipment - are at present executed during evenings and nights.

An exchange of Omega seal in the northern joint chamber is at present planned/ongoing, but this work can be executed without restrictions for the traffic in the tunnel.

The investigations of the condition of the tunnel structures, reported in the following Section 6 of this document, have in general been possible during evenings and nights and during the periods where a tunnel tube already has been closed due to maintenance works.

### 4.6 Recorded settlements

As explained above the leakages occurred already immediately after the construction of the tunnel, but at the same time some not expected big settlements started, and they have continued and show no signs of decreasing.

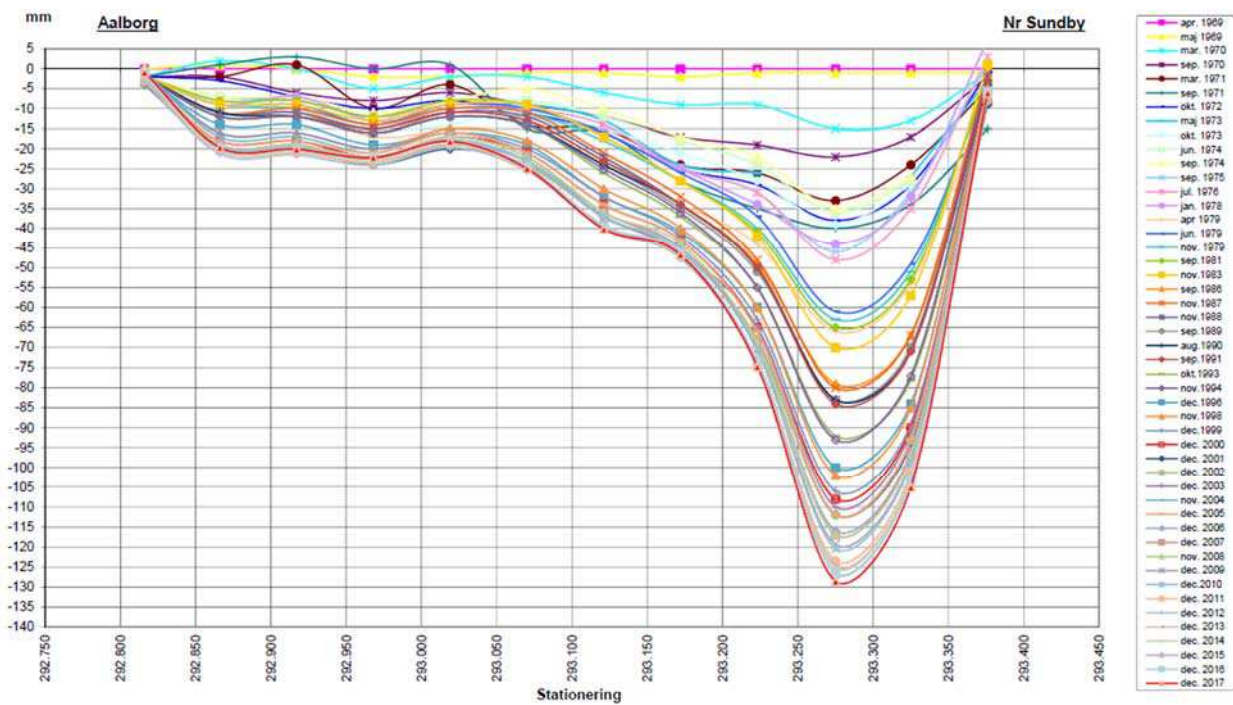

Figure 4.6-1 Recorded settlements during the period 1969 – 2017.

# 5 Geotechnical assessment

## 5.1 Summary of results, geotechnical expert group

The overall conclusions from the geotechnical expert group have been described in the background document and are summarised below.

Figure 5.1-1 illustrates:

- The location of tunnel elements along the alignment. The elevation of the tunnel elements refers to the right y-axis.
- The excavation level to which Gytija was removed and replaced by sand fill.
- Observed settlements per December 2017 are also included for both tubes. The measurements refer to the left y-axis.

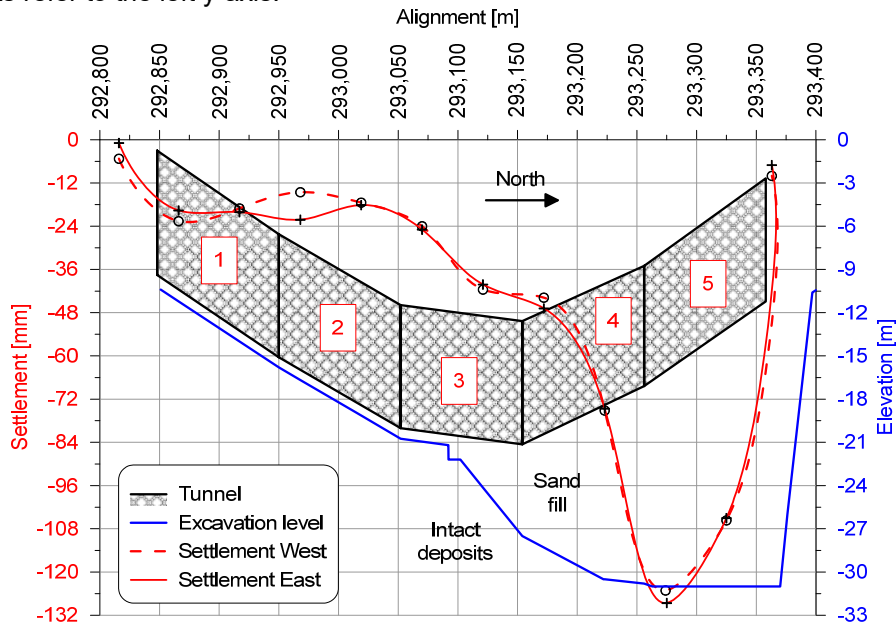

Figure 5.1-1 Tunnel elements along the alignment together with lower boundary for infilled sand.

Figure 5.1-2 is based on Figure 5.1-1. The blue curve represents the thickness of sand fill below the tunnel base (right y-axis), while the normalised settlements (red curve, left y-axis) represents the measured settlements from Figure 5.1-1 divided by the thickness of the sand fill.



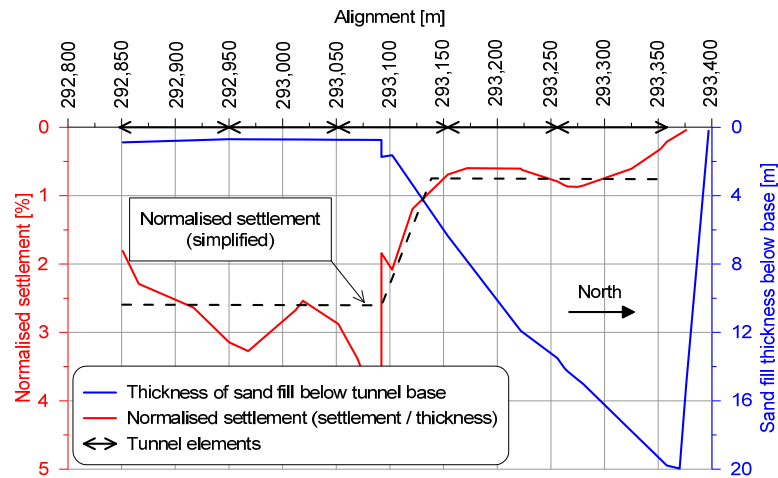

Figure 5.1-2: Thickness of sand fill below tunnel base and normalised settlement of tunnel as per December 2017.

Figure 5.1-2 shows that the normalised settlements are almost constant along the part of the tunnel being placed on sand fill, and this observation served as the working thesis for the geotechnical expert group during the project period.

The submerged weight of sand fill is approximately twice that of the replaced Gytija, so pumping in sand has caused an increased weight on the excavated base. The almost constant value of the normalised settlements along the sand fill part of the alignment implies two possible mechanisms:

- Settlements are caused by the increased weight from sand fill on the excavated base, and settlements will therefore originate from strata deeper than elevation -31 m, or
- Settlements are caused by settlements within the sand fill itself, i.e. above elevation -31 m.

Information from previous site investigations was combined with data from a series of boreholes and CPTs (Cone Penetration Testing) conducted in 2017 and assessed, the overall findings were:

- Placing sand fill within the excavated trench may have given rise to settlements within the intact deposits on Figure 5.1-1 of the order of 10-20 mm, but these settlements must have been fully developed before the tunnel was placed. Settlements within the tunnel can therefore not originate from the deeper strata.
- Samples of sand fill from the 2017 borehole campaign were tested within the geotechnical laboratory using oedometer testing with a 100 mm diameter oedometer ring. The sand fill was placed within the oedometer ring by under-water pouring to recreate the depositing history. The testing revealed that the stiffness of the sand fill was significantly lower than originally assumed during design in the 1960s.
- Full scale observations from sand fillings abroad revealed that loose and uncompacted sand fill will creep meaning that the material will keep settling for a considerable time.
- The creep behaviour will likely be amplified as the Gytija below the sand fill adjacent to the tunnel, cf. Figure 5.1-3, will continue to consolidate in in the long term (50 years or more) causing the sand around the tunnel to continue to settle.

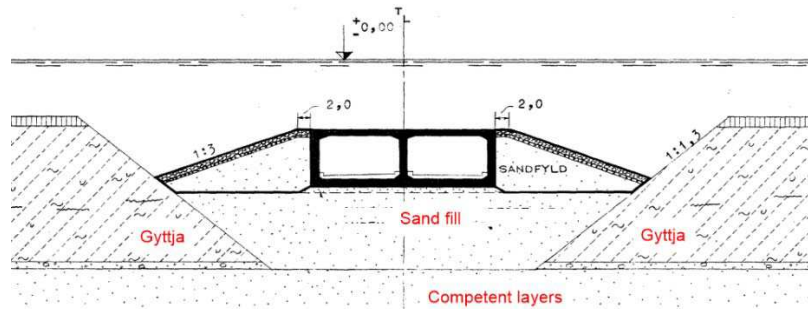

Figure 5.1-3 Cross-section of back-filled tunnel.

## 5.2 Input to structural assessment

The tunnel was placed in an excavated trench and sand was subsequently back-filled around the tunnel. Loading on the walls and on the base / top of the tunnel will therefore be influenced by soil and water pressures. Soil reactions have been summarised in the background document *Geotechnical summary note* [5] comprising:

- Soil springs simulating the effect of normal and shear stresses acting on the concrete faces of the tunnel. The spring stiffness has been estimated together with the maximum force within the spring following a linear elastic, ideal plastic approach. Recommendations are given considering the direction of the frictional force between the soil and the concrete faces.
- Pile capacities and axial pile stiffness for the driven concrete piles placed below the northern portal structure.
- An estimate of the extent of a possible void where the northern part of element V may have lost contact to the sand fill below the element.
- Various aspects considering different retrofitting scenarios.

# 6 Condition assessment

## 6.1 Introduction

This section contains a summary of the comprehensive condition assessment of the Limfjord Tunnel carried out in 2018 and 2019 as described in [19].

In order to carry out the structural calculations on the best possible basis it was decided to determine the actual strength of the original concrete based on cores from the tunnel. The testing was designed so that it could take into account possible differences in concrete quality between the different tunnel elements (as these have been constructed at different times) and between the different structural parts of the individual elements.

Coring has only been conducted on tunnel elements II, III and V as most of the challenges associated with the tunnel are linked to these three tunnel elements.

Further to compressive testing, condition assessment has been carried out on different parts of the Limfjord Tunnel as summarized in [Table 6.1-1](#).

Structural element	Compressive tests	HCP measurements	Break outs	Cores (Macro and micro analyses)	Chloride content	Water content
Top slab - outside				X	X	
Top slab - inside	X			X	X	X
Outer walls	X	X	X	X	X	X
Inner wall		X	X	X	X	
Bottom slab			X	X	X	

**Table 6.1-1 Overview of tests included in the condition assessment.**

From [Table 6.1-1](#) it is clear that the condition assessment is quite comprehensive. The condition assessment has focused on the following subjects:

- level of corrosion of the reinforcement (based on chloride content, water/moisture content, HCP measurements, break outs and cores),
- risk of delaminations (from cores),
- quality of structural concrete and repair concrete (based compressive tests, macro and micro analyses),
- signs of problems with overload and corrosion of welded rebars at immersion joints and closure joint (from visual inspection and break outs),
- condition of fire protection (from cores and visual inspection).

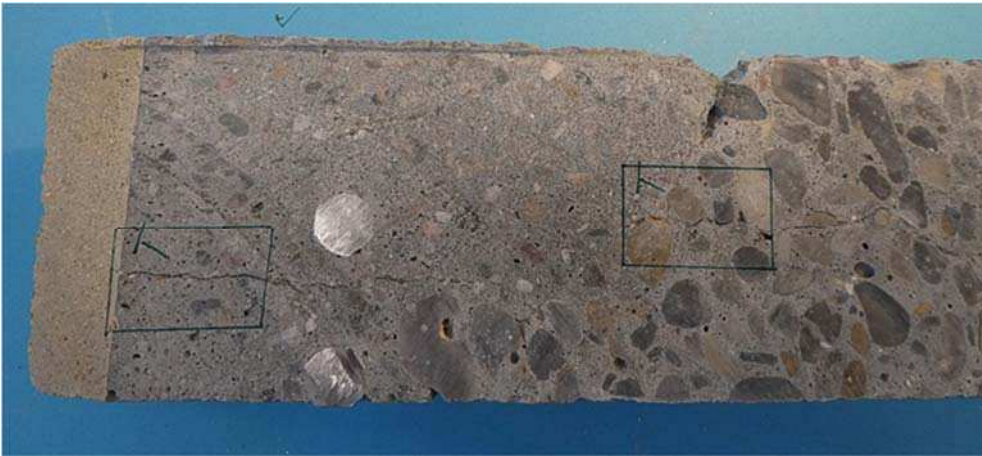

Figure 6.1-1 A concrete core from the roof has been cut in half in order to prepare for extraction of two thin sections (T).



Figure 6.1-2 Cores extracted from wall (cores without fire protection) and roof (cores with fire proofing).

## 6.2 Compressive strength

The cores have been grouped in nine different groups. Firstly, by tunnel element (II/III/IV), secondly by type of casting section (long/short)<sup>1</sup> and thirdly by structural part (wall/top slab). For each of these groups the characteristic in-situ compressive strength was determined.

The grouping of cores as well as the number of cores in each group can be found in [Table 6.2-1](#), showing a total of 43 tested cores.

<sup>1</sup> The meaning of long and short (casting) section is described in section 4.3.2.

The determined compressive strengths are also given in Table 6.2-1. It should be noted that the minimum average compressive strength of 300 kg/cm<sup>2</sup> originally required with nowadays terms corresponds to a characteristic strength of C25/30. Table 6.2-1 shows that the compressive strength determined in this project is significantly higher than the originally required strength.

Group	No. of cores	Characteristic in-situ compressive strength [MPa]	Indicative Compressive strength class
Element II - Long section, Top slab	4	47,9	C45/55
Element II - Long section, Walls	5	39,9	C35/45
Element II - Short section	4	45,6	C45/55
Element III - Long section, Top slab	6	50,0	C50/60
Element III - Long section, Walls	5	49,5	C45/55
Element III - Short section	4	53,5	C50/60
Element V - Long section, Top slab	6	50,8	C50/60
Element V - Long section, Walls	5	45,4	C45/55
Element V - Short section	4	47,8	C45/55
All cores grouped ( <b>weighted</b> average)	43	48,6	C45/55

Table 6.2-1 Calculated characteristic in-situ strength based on the assumption of a "known" coefficient of variation of 0,13. The corresponding compressive strength class according to DS/EN 206 is also shown.

## 6.3 Top slab

### 6.3.1 Outer part

Three aspects of the outer parts of the top slab have been of particular interest:

- The protective concrete (Integrity/Corrosion)
- The waterproofing membrane (Integrity)
- The condition of the outer reinforcement (Corrosion)

In order to investigate these topics, it was planned to take out 15 cores from the outside of the tunnel. Due to considerable practical problems related to the coring, only five cores were collected. The five cores, each with three layers (protective concrete, waterproofing membrane and structural concrete) have been analysed by macro- and micro analysis, supplemented with measurements of the chloride content. The cores are shown in Figure 6.3-1 together with samples of reinforcement collected together with the cores.

Figure 6.3-1 indicates that it was not possible to collect intact cores, which is assessed to be related to the difficult coring conditions and not the concrete quality. Generally, the protective concrete is seen at the top of the cores while the structural concrete is seen at bottom of the cores. The membrane can be seen between the two concrete layers in four of the five cores.



Protective concrete layer: The concrete generally consists of materials of good quality. Some alkali silica reactive particles have been observed but no damaging reactions have been observed.

The chloride content of the concrete is higher than 0,3 % chloride (by weight of concrete) throughout the layer. The rebars do not show any significant signs of corrosion despite the high chloride content. This is most probably due to lack of oxygen. Pitting corrosion cannot be excluded, but no signs have been observed. Generally, the risk of pitting corrosion is assessed to be low.

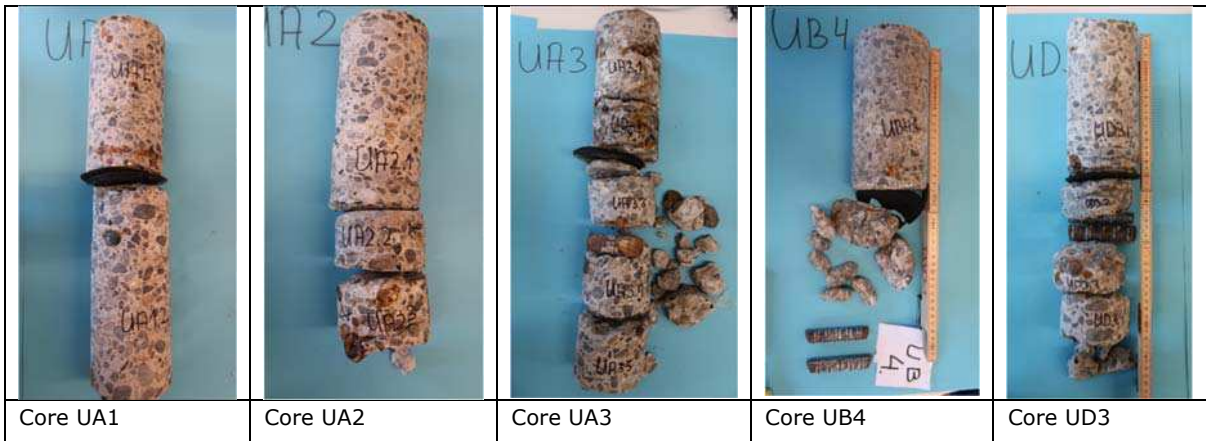

Figure 6.3-1 The five cores taken from the outside of the Limfjord Tunnel. The cores were taken from three different areas UA, UB and UD.

Waterproofing membrane: No signs of adhesion to either the underlying structural concrete or the protective concrete above have been observed. The membrane appears intact but has no to limited adhesion between the individual membrane layers.

Structural concrete layer: The concrete generally consists of materials of good quality, but some reactive particles have been observed. Some ASR-gel is present in cracks and voids, but no damaging reactions have been observed.

The chloride content appears high (between 0,16 and 0,78 % by weight of concrete) near the exposed surface (membrane side). A chloride content above the threshold value (0,1 % by concrete weight) is seen at reinforcement level. The rebars do not show any significant signs of corrosion despite the high chloride content. This may be due to lack of oxygen. Pitting corrosion cannot be excluded, but no signs have been observed.

### 6.3.2 Inner part

The following major repairs have been carried out at the inside of the roof slab:

- Repairs of major sections: 1995 – 1998.
- Fixation of delaminated concrete (delamination between original and repair concrete) with adhesive anchors: 2010 – 2011.

Due to the above repair works it has been of major interest to investigate the current condition of the repair works. The following topics have been of particular interest:

- Interface/cohesion between repairs and original concrete
- Chloride content and water content
- Corrosion (current level/risk of future corrosion)

### 6.3.2.1 Interface/cohesion assessment

In relation to the testing of the compressive strength, 32 cores were taken out from the top slabs. For each of these cores the interface between repair (if any) and original concrete has been assessed by visual inspection. The results of the assessment are summarised in [Table 6.3-1](#).

Assessed condition of interface	No. of cores [-]	Ratio [%]	Ratio, repairs [%]
No repair	15	47	-
Fully intact (80-100%)	7	22	41
Partially intact (50-80%)	10	31	59
Poor (<50%)	0	0	0
Sum	32	100	100

**Table 6.3-1** Assessment of interface between repair and original concrete based on 32 cores taken from the top slab.

In some cores fine cracks were observed in the interface, leading to an assessment of the interface being only partially intact – see example in [Figure 6.3-2](#). The cracks will in some areas act as means of transport of water longitudinally and transversely. This was observed in a number of holes left open after the coring.



**Figure 6.3-2** Core extracted from roof. The concrete is cracked both at the interface between repair and original concrete (red arrow) as well as within the original concrete (blue arrow).

From the above it is concluded, however, that the cohesion between the repair and original concrete is of reasonable quality. The interface will be able to contribute to the transfer of forces between repair and original concrete, which is a prerequisite for being able to consider the full section of the top slab when calculating the bending moment and shear capacity – see Section 7.5.5.

### 6.3.2.2 Chloride content

Chloride content has been determined on five cores. The results show significant variation in the chloride content from core to core and also within the single cores.

In three of the five cores the chloride content was determined as being below the threshold value of 0,10 % by concrete weight

The highest chloride content found in the remaining two cores was 0,12%, which is seen to be above the threshold value of 0,10%.

#### 6.3.2.3 *Water content*

The water content and the degree of water saturation have been determined on three cores. The water content was found to be between 2,9 and 4,9 %. The degree of water saturation was found to be between 77,6 % and 98,3 %.

#### 6.3.2.4 *Corrosion (current level/risk of future corrosion)*

The current level of corrosion has been evaluated from Half Cell Potential (HCP) measurements and break outs. HCP measurements have been carried out in five areas.

For the top slab, the HCP values and the deterioration of the fire protection are correlated:

- In areas with deteriorated fire protection – due to water ingress over a long period – there are low (i.e. more negative) HCP values, indicating a risk of corrosion (or higher water content in the concrete).
- In areas with intact fire protection – due to no or limited water ingress – there are higher HCP values indicating limited risk of corrosion (or dry concrete).

Despite low HCP values in some areas, no corrosion was observed on the reinforcement – see example in [Figure 6.3-3](#). This is valid for all reinforcement examined in the cores – and all the break outs performed on-site to calibrate the HCP measurements.

The HCP-measurements were supplemented with corrosion rate measurements. All measurements of corrosion rate showed "very low" to "low" corrosion rate – again indicating a high probability of no significant ongoing corrosion.

In areas with signs of water ingress (usually indicated by a lighter colour of the fire protection), water was typically dripping from the original concrete shortly after break outs were established – even though the surface seemed dry before the break outs.

In areas with no signs of major water ingress (dark colour of the fire protection) the original concrete was dry in the break outs.

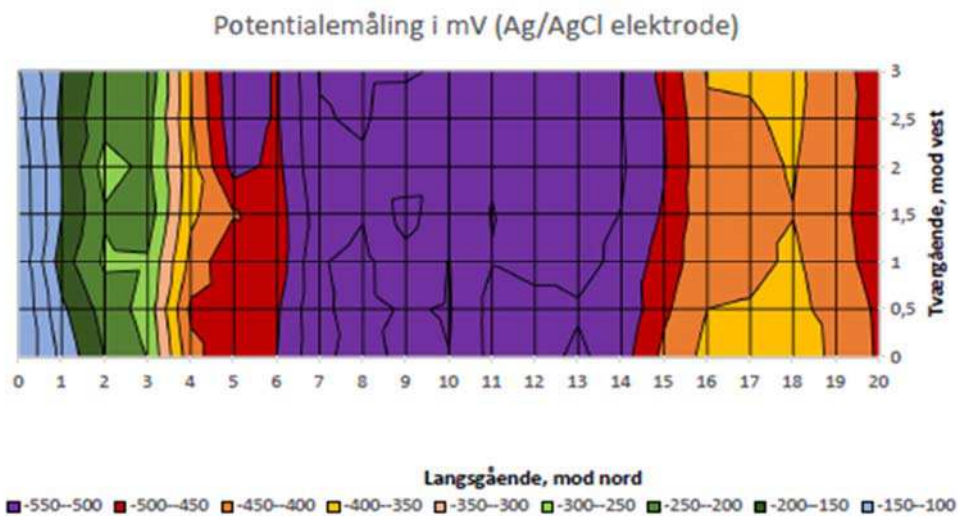

Figure 6.3-3 HCP results from roof. The whole area was wet. No corrosion observed on reinforcement in break out despite the very low potential (-600 mV). Investigated area at transition between element II (left - 3 m) and element III (right - 17 m).

### 6.3.3 Fire protection

The fire protection layer on the soffit is deteriorating in some areas where it can be removed by hand. It is assumed that the fire protection in these local areas no longer protects the concrete fully against fire. These areas appear lighter in colour compared to areas with intact fire protection. It is assessed that this is because salt crystals build up in the fire protection causing it to slowly peel off.

It is found that the deterioration is connected to the ingress of water, cf. previous section.

The level and extent of deteriorating fire protection has not been registered in detail but can be observed from the cores taken in the roof.



Figure 6.3-4 Area where fire protection has deteriorated.

## 6.4 Outer walls

For the outer walls the main concern is the level of ongoing corrosion as well as the risk of future corrosion of the reinforcement. Corrosion may lead to delamination as was observed prior to the substantial repairs of the walls in the late 1990's.

### 6.4.1 HCP measurements and break outs

HCP-measurements have been carried out in five areas on the outer wall of the eastern tube.

The HCP values measured in the wall – where this is covered with tiles – are high, indicating low risk of corrosion. Break outs to the reinforcement showed no signs of corrosion.

The HCP measurements were supplemented with corrosion rate measurements. All measurements of corrosion rate showed "very low" to "low" corrosion rate – again indicating a high probability of no significant ongoing corrosion.

In areas with signs of water ingress, water was typically dripping from the original concrete shortly after break outs were completed – even though the surface seemed dry before the break outs. The repair concrete, together with the tiles, seem to function as a waterproof layer keeping the water inside the original concrete. In areas with no signs of major water ingress the original concrete was dry in the break outs.

Despite the dry surface of the tiles and tile joints, water is also coming out from holes drilled for concrete dust samples or for making HCP measurements at the surfaces covered by tiles. This indicates that the concrete behind the tiles is saturated with water.

### 6.4.2 Chloride content

From the inside of the eastern wall 15 chloride profiles have been determined.

In 4 different locations samples were taken in three different heights. In three of these 4 locations all profiles showed chloride content well below the threshold of 0,10% (by weight of concrete). In the fourth location the chloride content varied between <0,005 % and 0,17 %.

In [Figure 6.4-1](#) three chloride profiles determined from cores are shown. As can be seen from the figure, in a few instances (8 out of 54 samples) the chloride content is found to be above the threshold value of 0,1 %.

### 6.4.3 Water content

The water content and the degree of water saturation have been determined on three cores. The water content was found to be between 2,7% and 6,5 %. The degree of water saturation was found to be between 77,3 % and 94,1 %.



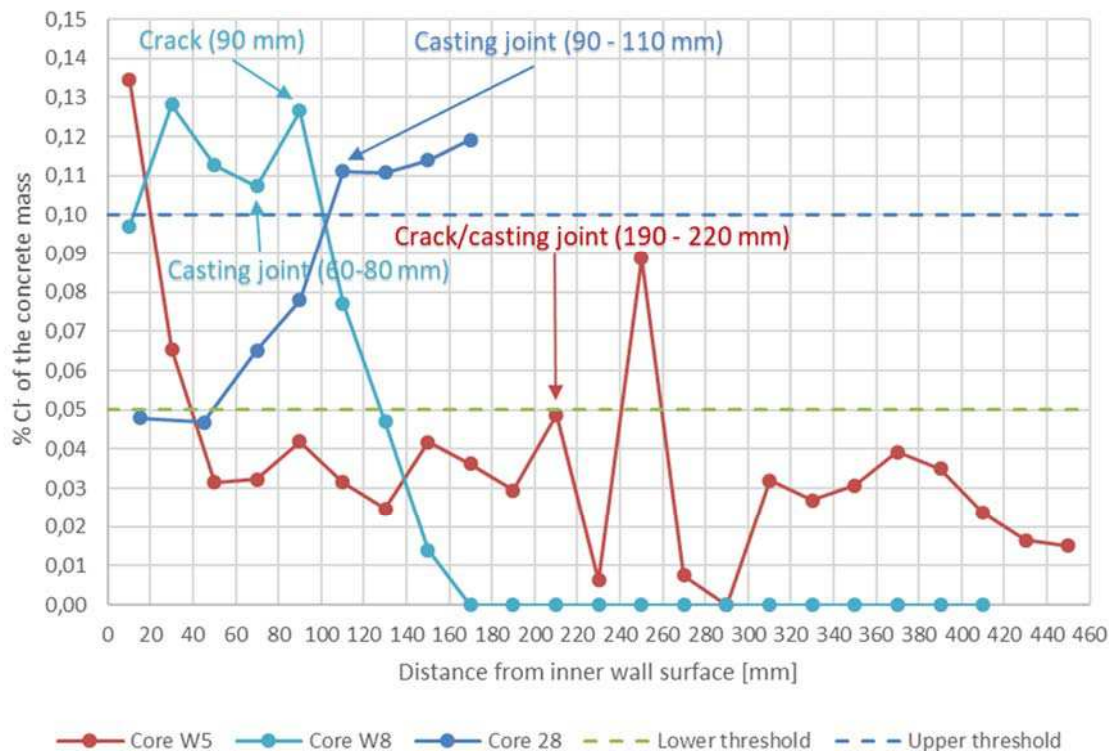

Figure 6.4-1 Chloride profiles from three cores taken from the inside of the eastern wall.

## 6.5 Mid wall

### 6.5.1 HCP measurements and break outs

A single area has been selected for HCP measurements at the same location where the lowest HCP values were observed for the top slab and outer wall. The HCP measurements indicated no risk of corrosion. Further to that, two break outs showed dry concrete and no signs of corrosion of the reinforcement.

### 6.5.2 General condition

No chloride measurements were made from the concrete in the mid wall. Also, no measurements of the water content were made. The concrete (both behind and above tiles) are assessed having a low water content as the water exposure is low. Generally, the mid wall is assessed to be intact with no ongoing deterioration.

## 6.6 Bottom slab

A single core has been extracted to examine the ballast concrete and the upper 200 mm of the structural concrete in the bottom slab. No signs of deterioration were observed on the ballast concrete (old and new) or in the concrete in the bottom slab.

### 6.6.1 Post tensioning cables

Two concrete cores were extracted from the concrete cast between the post tensioning cables – no defects were observed. A single break out to a post tensioning cable and subsequent opening of a cable duct showed no signs of anomalies or deterioration. The concrete, the cable ducts, the injection

mortar and the strands were all without signs of deterioration and without deviations from specifications and drawings.

### 6.6.2 Chloride content

Chloride profiles have been determined from two cores taken from the bottom slab. The core B2 is taken in the part of the bottom slab where the post tensioning cables are situated. The core B3 is from part of the bottom slab/ballast concrete without post tensioning cables.

The chloride contents determined in the bottom slab are shown in [Table 6.6-1](#). As can be seen from the table, a number of the samples show chloride content above the upper threshold of 0,1 %.

Core	Concrete type	Distance "0" corresponds to:	Distance from surface / from membrane [mm]				
			0-10	10-20	20-30	30-50	50-70
B2	Repair ballast concrete I	Underside asphalt	0,19	0,02	<0,005	<0,005	<0,005
B3	Ballast concrete	Casting joint between ballast concrete and structural concrete and up in the ballast layer.	0,17	0,11	0,10	0,06	0,02
B3	Structural concrete	Casting joint between ballast concrete and structural concrete	0,10	0,15	0,13	0,13	0,10

**Table 6.6-1 Chloride contents (by concrete weight) determined on three cores taken from the bottom slab.**

The results in [Table 6.6-1](#) indicate that the primary route for chloride ingress is through the casting joint between structural concrete and ballast concrete.

As the concrete cast between the post-tensioning cables is well described and tested during the repair, it is assessed that significant chloride ingress is unlikely. This assessment is supported by the chloride testing of core B2 where chlorides are only present in a significant amount in the upper most 10 mm.

Special attention shall however be given to various areas inclusive the construction joints at the anchorage zones of the post-tensioning system.

## 6.7 Immersion joints and closure joint

The immersion joints and closure joint have been given special attention. The main concern has been the condition of the welded connections that secures the transfer of forces in the horizontal reinforcement through the five normal immersion joints and the special closure joint between element V and the in-situ build part of the northern portal structure. The layout of the two types of joint is shown in [Figure 6.7-2](#).



Figure 6.7-1 Closure joint between Northern Portal (NP) and Element V (E5) before removing tiles and concrete in order to inspect the reinforcement.

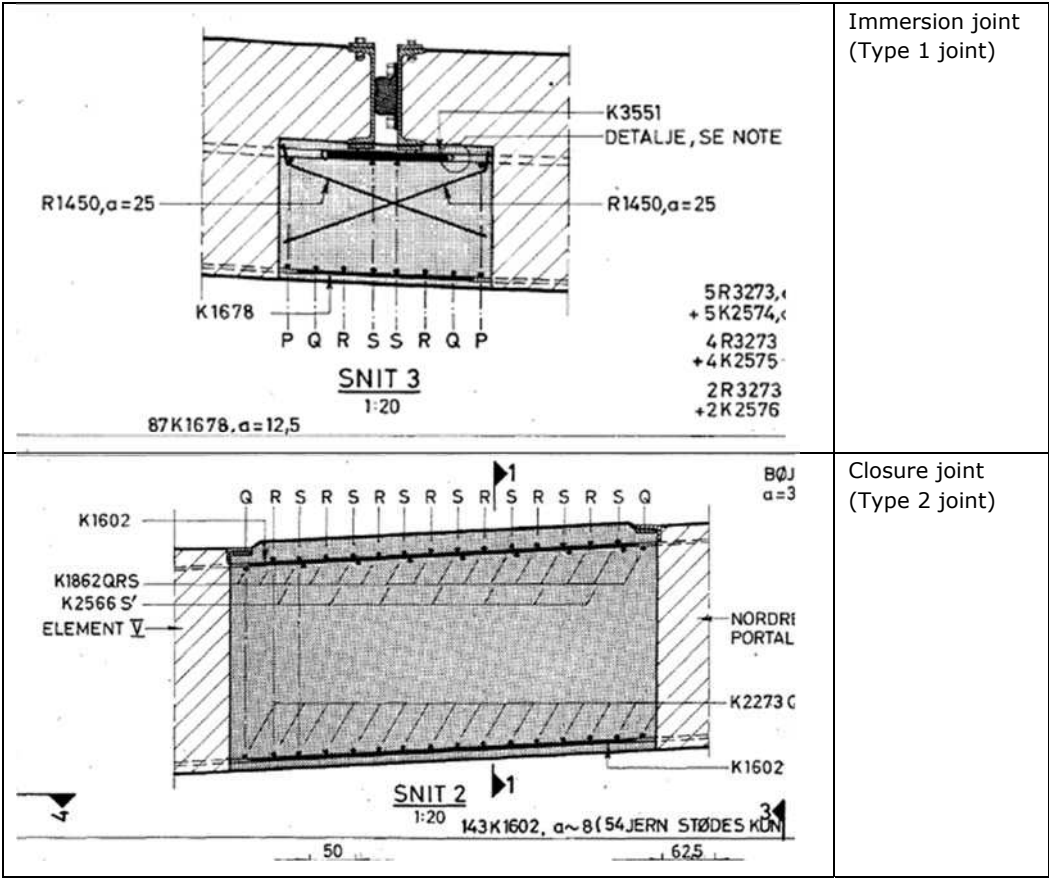
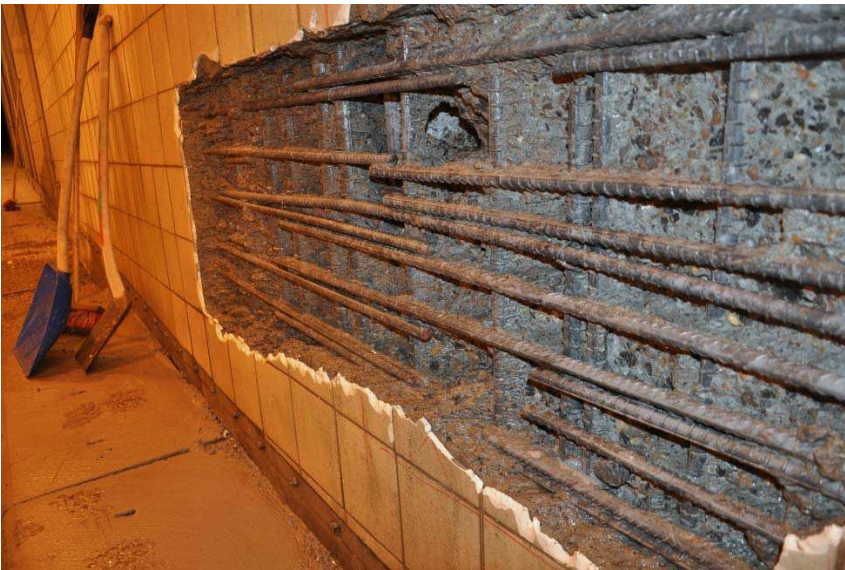

Figure 6.7-2 Layout of immersion joints and closure joint.

It was decided to concentrate inspections on the closure joint as this is the most critical joint. The inner layers of the reinforcement were exposed by means of water jetting at a rather large part of the closure joint.

No signs of butt-welded reinforcement were found in the exposed area – see [Figure 6.7-3](#). Instead numerous traditional laps were found.



[Figure 6.7-3](#) Exposed reinforcement at the closure joint (Type 2 joint). No signs of butt-welded connections in the horizontal reinforcement.

It has not been possible to determine whether the butt-welds were never made or whether they have been exchanged with laps during the repairs in the late 1990's. However, several photos taken during construction have shown that butt-welds were made in some places with the specified "sharpening" of reinforcement ends and subsequent butt weldings, see [Figure 4.3-8](#). It is therefore quite possible that the butt weldings were made as specified in the drawings.

All the exposed reinforcement – original and new – in both original and repair concrete was found to be intact and with no major signs of corrosion. A few minor signs of corrosion of the reinforcement was found – but all with no reduction of cross-sectional area.

## 6.8 Conclusions

The following main conclusions can be drawn in relation to the condition assessment of the Limfjord Tunnel:

- The characteristic compressive strength of the concrete has been determined to be a minimum of 40 MPa compared to the original requirement of 25 MPa.
- The outer waterproofing membrane is found to have limited function and is unable to prevent water ingress into the concrete structures.
- Numerous cases of leaking water have been observed in core holes and break outs indicating that the tunnel structures are heavily exposed to water ingress.
- Close connection between deterioration of fire protection and moisture ingress in roof is found.

- Delamination between repairs and structural concrete have been observed in some areas. It is assessed that these delaminations will act as transport ways for water penetrating through the concrete from the outside.
- High chloride contents have been found in several samples. In other samples very low chloride contents have been determined.
- No signs of significant corrosion of reinforcement have been observed during inspections. Hence, it is considered that the reinforcement is generally in good condition. The assessment is that:
  - Repairs effectively protect reinforcement against corrosion.
  - Lack of oxygen prevents the corrosion of reinforcement in deeper lying parts of concrete sections as these are generally water saturated. This also goes for the outside reinforcement. It should be noted, however, that for the outside reinforcement this is only based on five cores.
- It is assessed that the interface between repair and original concrete in the roof is of such quality – irregular in surface and well-cast – that significant shear capacity is present. Based on visual inspection of cores it is assessed that at least 50 % of the cross section may be accounted for in shear.
- Exposed reinforcement in the closure joint proved to be fully intact. Signs of major problems in other parts of the joints (immersion joints and closure joint) have not been observed. Hence, it is concluded that there are no immediate problems with the load bearing capacity of the joints.
- It is strongly recommended to keep the tunnel under increased observation by comprehensive monitoring and inspection activities due to the high exposure to water ingress and significant chloride contents seen in some areas of the tunnel. See section 8 for further details on this.



# 7 Structural assessment

## 7.1 Introduction

This section describes the structural analyses carried out, the background / purposes, the assumptions and the results.

The analyses are divided into two groups:

1. Longitudinal analyses
2. Transverse analyses

## 7.2 Purpose

The overall purpose of the structural analyses is to verify that the structural safety is satisfactory for all cross sections in both the longitudinal and transverse direction.

The purpose is also to analyse the effects in the longitudinal direction that causes the continuous leakages and penetration of seawater, which has an impact on the operation and durability of the tunnel. I.e. the yearly contraction of tunnel due to thermal actions (cooling) and the on-going settlements in the northern end of the tunnel that increases the tensile stresses in certain areas of the tunnel.

## 7.3 Safety, loads combinations, loads and material strengths

The verification is carried out in accordance Eurocodes including Danish national annexes for bridge and “Handbook, Guidance on loads and basis of design, bridges”, which includes supplementary rules for existing bridges. Interface shear between original and repair concrete in the roof has also been verified in accordance with FIB Model Code for Concrete Structures, 2010, which also is used as basis for the non-linear elastic analyses carried out by Finite Element Model (FEM) Software DIANA.

The structure belongs to consequence class CC3, i.e. a  $K_{FI}$  factor of 1,10 shall be applied to all unfavourable loads.

The governing load combination is supposed to be (6.10a) – permanent loads dominating, see Table A2.4 (B+C) DK NA in DS/EN 1990/A1 Annex A2 DK NA. For this load combination no variable loads are considered. The partial safety factor on the unfavourable permanent loads is in this case 1,25. It should be mentioned that buoyancy is considered as an integrated part of the total dead load of the tunnel corresponding to an immersed “voided” beam, i.e. that the  $K_{FI} \times 1,25 = 1,38$  shall be applied to both the dead load and buoyancy of the tunnel. This corresponds to applying the same factors to the water pressure when analysing the tunnel in the transverse direction. It should be noted that a partial safety factor of 1,00 has been used for settlements.

Unit weight of the structural concrete is assumed to be  $24,5\text{kN/m}^3$  based on measurements done on test pieces from cores taken out of the concrete structures as part of the condition assessment. Unit weight of ballast is assumed to be  $24\text{ kN/m}^3$ .

On the resistance side, the partial safety factor for the original reinforcement FKF 42 (weldable ribbed rebars, K), is reduced to  $\gamma_s=1,12$  because this type of rebars was produced with a guaranteed yielding strength of 410 MPa, assumed to correspond to 0,1% fractile value.

The concrete compression strength has been measured in the laboratory for the drilled-out cores as part of the condition assessment programme. Based on the results (groups of cores from different tunnel elements, and total number of cores) a compressive strength of 40 MPa (5% fractile value) can be assumed in the capacity calculation of the concrete sections. The corresponding safety factor can be reduced to  $\gamma_c = 1,45 \times 0,95 = 1,38$  because the tests have been made on cores from the actual structure, which is considered comparable to tightened control.

A more detailed description of the basic assumptions can be found in the Design Basis [8].

### 7.3.1 Accidental actions

#### 7.3.1.1 Fire

Fire protection has been applied. A risk assessment with regards to installation of various fixed fire fighting systems has been performed, but not as part of this project, cf. [22]. Follow-up activities on the condition of the fire protection and on the risk assessment are outside the scope of this project.

#### 7.3.1.2 Ship impact scenarios

A preliminary risk analysis of ship accidents has been carried out evaluating whether the annual frequency of accidents causing damage severe enough to threaten life safety exceeds the annual acceptance criterion of  $10^{-5}$  per tunnel element, cf. [17].

The ship accident comprises impact scenarios such as sunken ship resting on the tunnel roof, dropped anchor on the top of tunnel roof, dragged anchors and grounding ships. The tunnel elements exposed to risk of ship accident are tunnel element II to V.

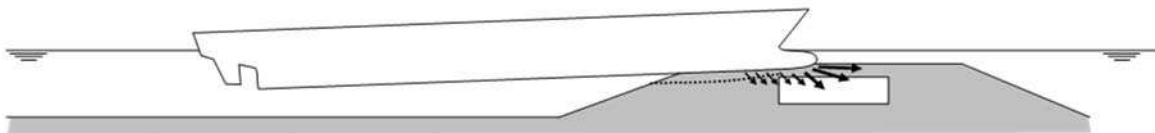

Figure 7.3-1 Representative Cruise ships at Limfjorden (top). Principle sketch of grounding ship (bottom).

The analysis concludes that:

- For elements II, III and IV, which are not exposed to risk from grounding ship, the resulting risk for loss of life satisfies the annual acceptance criterion
- For element V, mainly exposed to risk from grounding ships, the annual accident frequency estimated with preliminary considerations exceeds the annual acceptance criterion. A specific protective structure is likely required to mitigate the risk. In order to establish a reasonable design load for the protective structure, it is recommended to carry out a more detailed risk analysis for grounding ships.

#### 7.3.1.3 Flooded tunnel

The case of a flooded tunnel has been analysed by using the longitudinal model 1, see Section 7.4.7.

## 7.4 Longitudinal analyses

### 7.4.1 Introduction

The longitudinal analysis and structural verification are based on the results presented in the following reports:

1. Longitudinal indicative analyses including appendices, refer [9]
2. Longitudinal indicative analyses – Beam Model, refer [11]

### 7.4.2 Structural system

The tunnel is designed as a monolithic structure resting on various types of subgrade and fill and carrying various types of back fill, erosion protection and sedimentation loads. At the northern portal building the tunnel is resting on reinforced elastomeric bearings. Due to the monolithic composition of the structure the temperature deformations are accumulated at the tunnel ends.

### 7.4.3 FE-models

The following models have been used for the analyses of the structural behaviour in the longitudinal direction.

1. Model 1: 2-D “shell” model using FEM software LUSAS where both settlements, temperature effects and prestressing have been analysed. Parts of the settlements are applied as imposed settlements.
2. Model 2: 3-D shell model using FEM software LUSAS where settlements and prestressing, but not temperature effects, have been analysed. Parts of the settlements are applied as imposed settlements.
3. Model 3: Beam model using FEM software Autodesk Robot Structural Analysis Professional 2019 where settlements and prestressing, but not temperature effects, have been analysed. In this model the tunnel is resting on soil springs, which are adjusted to fit the actual settlements. The model is used for the validation of the results of model 1 with regard to bending and shear.



Figure 7.4-1 Model 1: 2D shell model.

#### 7.4.3.1 Geometry

The tunnel has been modelled in full length in all three models. The actual longitudinal profile has been used for both model 1 and 2, see [Figure 4.1-2](#).

#### 7.4.3.2 Sectional properties

In model 1 and 2 parts of the cross-section that are in tension are given a lower E-modulus than parts of cross-sections in compression. The reason is that the cross-sections are basically cracked. This causes a significant decrease of the stiffness due to the low amount of longitudinal reinforcement. The structure is born with cracks due to the construction sequence (early age thermal and shrinkage cracks). Furthermore, cracks have developed caused by tension as a result the contraction of the tunnel during winter time. For model 1 and 2 the following E-modulus have been used:

- Compression:  $E = 17.000 \text{ MPa}$
- Tension:  $E = 5.000 \text{ MPa}$

In model 3 a single value of E-modulus, of either  $E = 11.000 \text{ MPa}$  or  $13.700 \text{ MPa}$  corresponding to an average of the compression and tension E-modulus has been adopted for the whole tunnel.

#### 7.4.3.3 Support conditions

For model 1 and 2 the vertical supports are modelled by soil springs. The spring stiffnesses have been estimated based on the information provided in the Geotechnical Summary note [5]. The creep of the underlying sand fill in the northern end has been modelled as imposed settlements. The most suitable combination of soil spring stiffnesses and imposed settlements in the northern end has been found by iteration.

For model 3 imposed settlements are not considered. The soil reaction distribution is determined through an iteration process with the springs stiffnesses and with an assumed area with no support, only compression in springs are allowed for.

For model 1 the longitudinal soil structure interaction has been modelled by introducing non-linear shear springs along the bottom, roof and the outer walls in order - the soil is resisting longitudinal deformation of the tunnel, thereby building up axial tension (or compression). The shear stiffnesses are calculated based on the shear capacities of the soil at the actual location and depth of the element in question. A linear elastic - perfect plastic shape of the shear resistance diagram as a function of the deformation has been assumed. The best fit to the actual measurement of temperature deformations and deformations from the prestressing at the tunnel ends corresponds to a max shear deformation of 20mm in the elastic range.

Furthermore, the best fit to the measured longitudinal deformations is found by assuming no interaction between the shear resistance against the prestressing deformations and against the temperature deformations respectively, which corresponds to full regeneration of the shear resistance of the soil after prestressing (that happened only once) before applying the temperature actions that repeats every year.

#### 7.4.3.4 Loads

Following loads are considered:

- Self-weight of tunnel, ballast concrete, road surfacing and protective concrete
- Fill, erosion protection, sedimentation loads
- Vertical soil friction on sides (hanging soil)
- Settlement

- Water pressure / buoyancy
- Prestressing (according to design and drawings; corrected for the presence of the ballast concrete)
- Temperature action – only model 1: Contraction corresponding to max. temperature range between summer and winter of  $\Delta T = 14^{\circ}\text{C}$

#### 7.4.4 Results, sectional forces and stresses

##### 7.4.4.1 Model 1, 2-D shell model

The calculations show that the northernmost part of the tunnel is spanning freely from the bearings at the northern portal building and approximately 70m further south (tunnel element V).

Concrete stresses in the top and bottom slab for the base model (year 2017) are shown in [Figure 7.4-2](#).

The peak stresses for tunnel element IV and V clearly reflect the significant sagging and hogging moments caused by the settlements. The discontinuous curve for the bottom slab reflects the locations where the post-tensioning forces are applied (anchorage points).

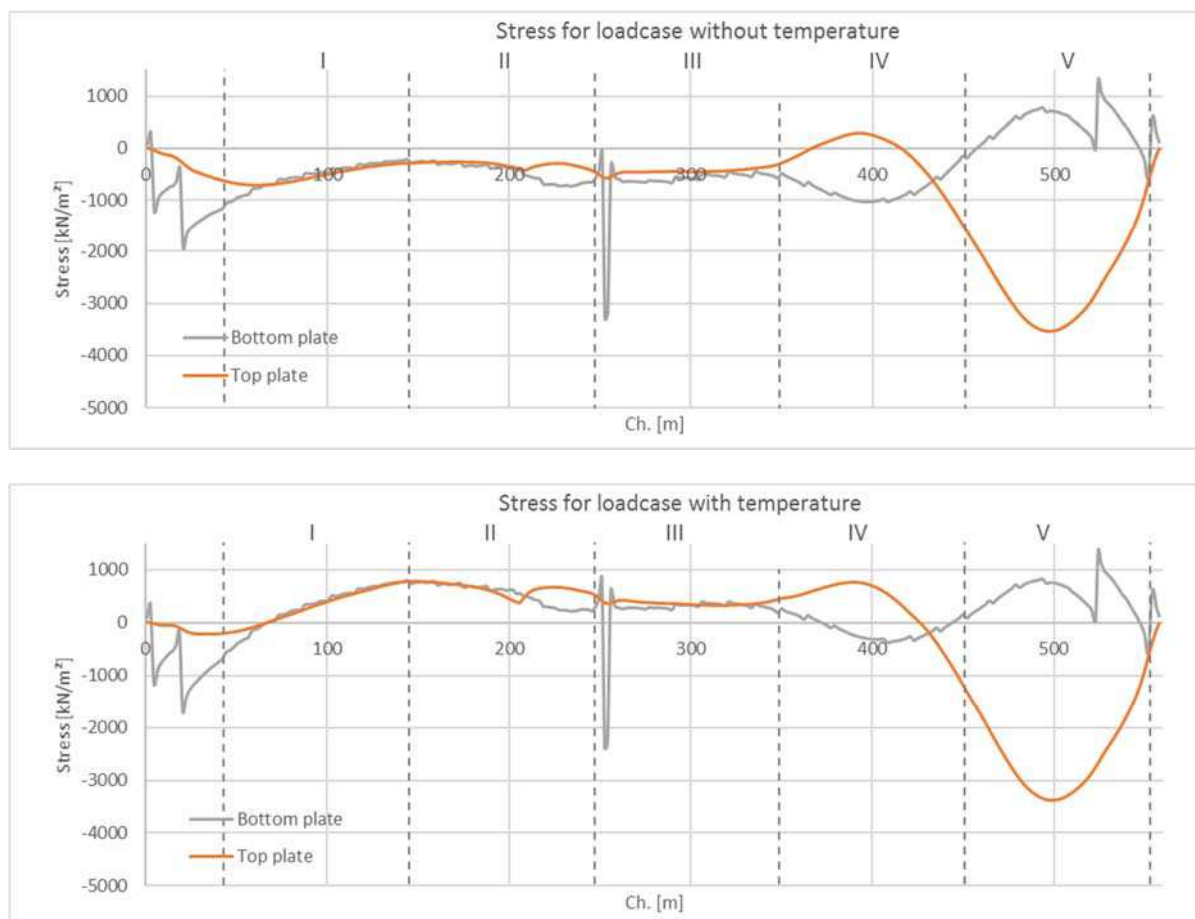

Figure 7.4-2 Model 1, Base model (year 2017). Concrete stresses in top and bottom slab, upper figure without temperature, lower figure with temperature. Alignment 0 is located at the southern expansion joint corresponding to the global alignment 292.805.



It is also clearly seen how the temperature contribution (contraction) increases the tensile stresses significantly and brings the main part of top slab / roof into tension, although post-tensioning has been installed. This means that post-tensioning is not fully efficient with regards to closing the cracks and keeping the cross-sections permanently under compression. Hence, the water is still able to penetrate the existing cracks caused by early age thermal effect / shrinkage and further developed by axial tension from temperature effects before prestressing was applied. That is why leakages are still seen every year, although the tensile stresses are generally lower than the tensile strength. In other words, the cross-sections are not able to satisfy the crack width criteria to ensure a watertight structure (SLS).

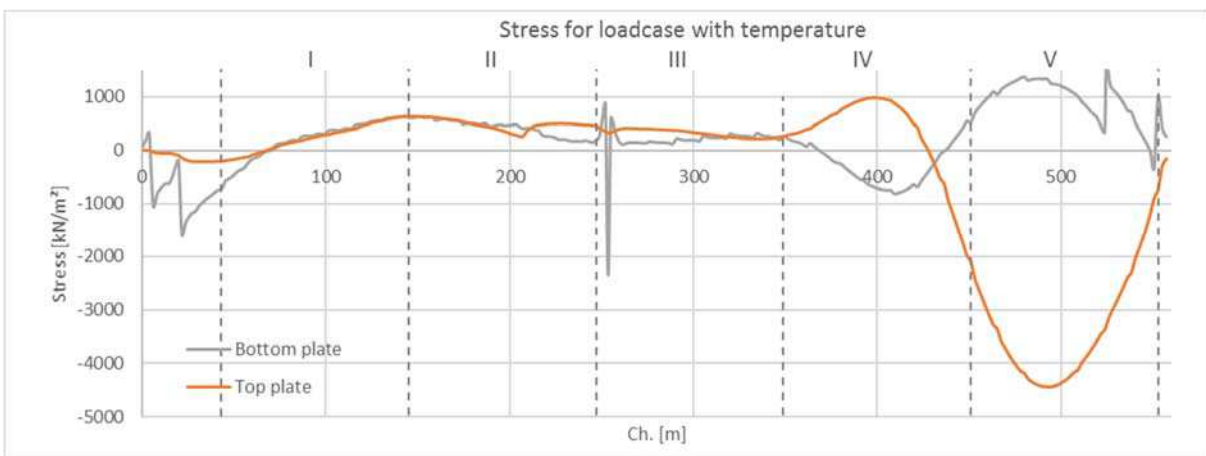

Figure 7.4-3 Model 4, Future scenario (year 2069), increased settlements, Stresses in top and bottom slab including temperature

In Figure 7.4-3 the similar stresses are shown for the future situation in year 2069 with increased settlements. Obviously, the tensile stresses both in the top slab and the bottom slab are increased, but the corresponding reinforcement stresses are well below the design yielding strength when applying safety factors in Ultimate Limit State (ULS). However, with regards to leakages, an increase might be expected in the future because of an increase of the tensile stresses mainly in tunnel element IV and V.

The future scenario of differential settlements shown on Figure 7.4-4 is based on a conservative extrapolation of the current settlements with increase of approx. 60 mm (at point of max) in the next 50 years. An additional 30 mm is added in the verifications, see Section 7.4.6.

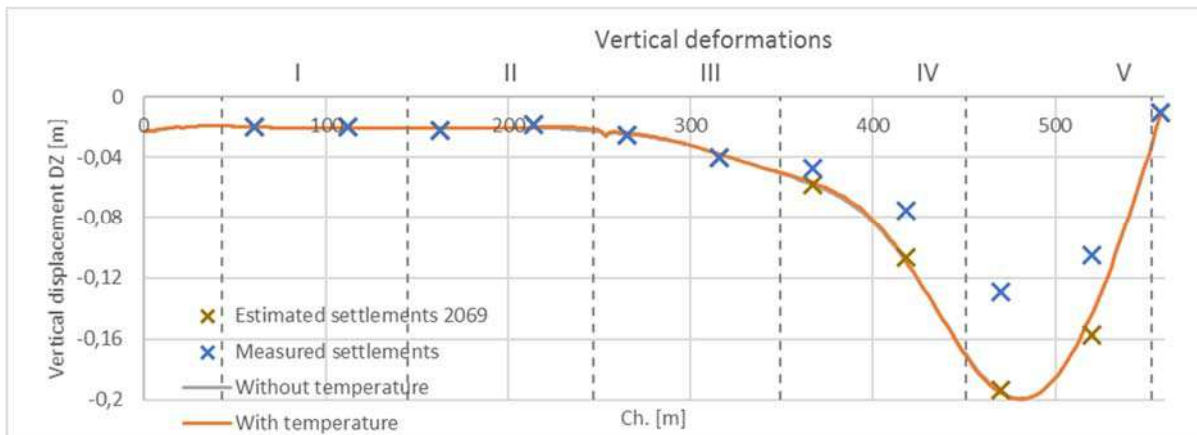

Figure 7.4-4 Model 4, Future scenario (year 2069), increased settlements

#### 7.4.4.2 Model 2, 3-D model

The analyses carried out by the 3-D model have shown that the deflections of outer walls are approximately 10mm bigger than the deflections of the central wall for element III, IV and V. It should be noted that the measurements on site are done to the outer walls.

Further, the 3-D model shows that the distribution of shear forces between the walls at the northern end is very close to 33% - 33% - 33%, even considering various support conditions transversely. In the C&N design calculations a 30% - 40% - 30% distribution is assumed.

#### 7.4.4.3 Model 3, 2-D beam model

In general, good agreement is found between the results of model 1 and model 3, which has been used to validate the results of model 1. However, the sectional forces and the soil reaction forces and bearing reaction forces are slightly higher for model 3 for the case where vertical soil friction on sides (hanging soil) are included. For more details reference is made to [11] and [9].

#### 7.4.5 Sensitivity analyses

Several sensitivity analyses have been performed:

- With varying E-modulus of the concrete
- With / without vertical soil friction on sides (hanging soil)
- Without sedimentation load on top of element V
- With various free spanning length 80m, 100m, 120m, 150m

From the sensitivity analysis it is observed that with 'hanging soil' will the sagging moment increase by approx. 10% and the bearing reaction forces by 18%, and that removal of the sedimentation load will decrease the sagging moment by approx. 15% and the bearing reaction forces by 20%.

For further results, reference is made to the sensitivity analyses reported in [11] and [9].

#### 7.4.6 Capacity verifications

Following capacity verifications have been carried out in the longitudinal direction in ultimate limit state:

1. Bending moment capacity, sagging and hogging moments
2. Shear capacity, global shear

3. Shear in constructions joints between casting and filling sections and elements
4. Bearings
5. Piles under northern portal building carrying the bearings.

The utilization ratios have been calculated for both the expected lifetime of the tunnel, i.e. 50 years from now on (year 2069), which is assumed to correspond to additional settlements of max 60 mm, and for additional settlements of 60 + 30 =90 mm.

#### 7.4.6.1 Bending moment capacity

The design bending moment diagrams are shown in [Figure 7.4-5](#) and [Figure 7.4-6](#) for both the future and current state. The difference between the diagrams in the two figures is the first one considers the post-tensioning on the load effect side only, while the other one considers only the secondary effects of post-tensioning on load effect side. The most critical of the values from the two figures have been used for calculating the utilization ratios.

The bending moment capacities have been calculated assuming fully embedded prestressing cables, which is actually not the case. The cables are only structurally connected to the tunnel in the anchorage zones and where the deviators are placed. Therefore, reduced bending capacities corresponding to the yield strength ( $f_{p0,1k}$ ) have been calculated as well, see [Table 7.4-1](#). And the utilization ratios are determined based on the latter. For more details reference is made to Appendix 3 of Longitudinal indicative analyses [9].

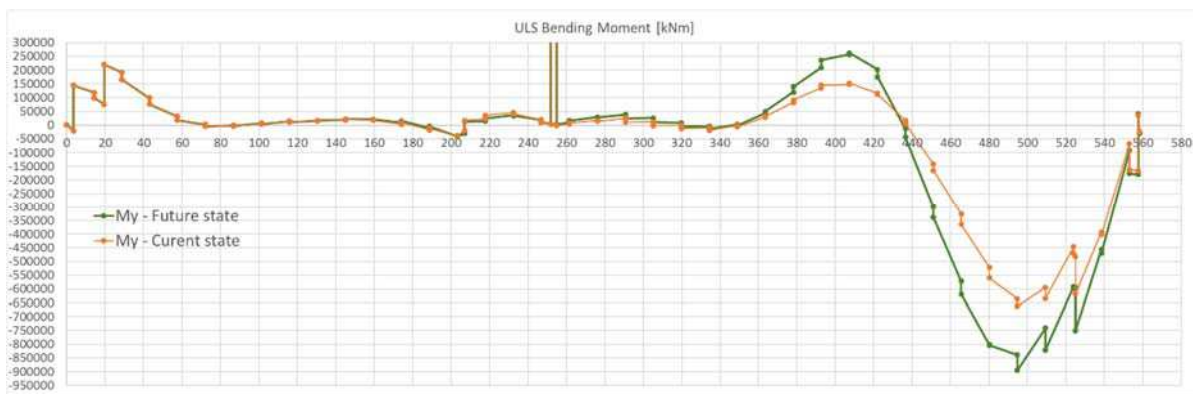

Figure 7.4-5 Bending moment in longitudinal direction, ULS combination values (total PT), current and 2069 state

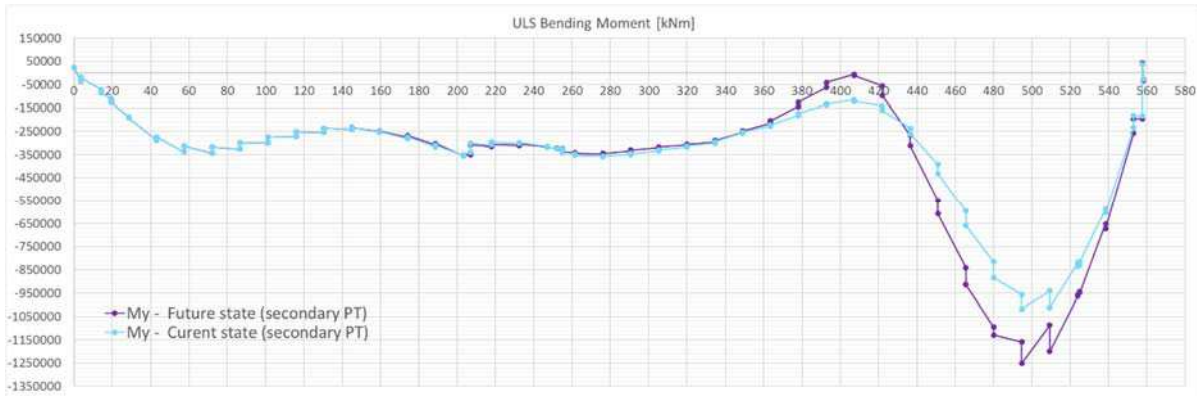

Figure 7.4-6 Bending moment in longitudinal direction, ULS combination values (Secondary PT), current and 2069 state

	X=55m (max sagging moment)	X=32m (sagging moment junction of cables)	X = 150m (max hogging moment)
<b>Full capacity of cables</b>	1586 MNm	1267 MNm	393 MNm
<b>Limited capacity of cables</b>	1463 MNm (0,85)	1198 MNm (0,79)	383 MNm (0,65)

Table 7.4-1 Bending moment capacities and utilization ratios, longitudinal direction (X indicates the distance from the bearing support at the Northern Portal Building).

It should be noted, that the increase of the settlements will increase the tensile stresses in the roof and base slab, which may increase the amount of leakages. This depends on the ability of the structure to form new cracks and redistribute stresses.

#### 7.4.6.2 Shear capacity, global shear

The utilization ratios for global shear are shown in Table 7.4-2. The shear capacities are calculated in accordance with the compression diagonal method as described in section 6.2.3 in DS/EN 1992-1-1 including DK NA. The utilization ratios shown are calculated based on conservative assumptions (only half of the vertical reinforcement taken into account is case of inadequate anchorage and asymmetric position of vertical rebars (outer walls)

#### 7.4.6.3 Shear in construction joints

The utilization ratios for the shear capacity verifications for construction joints are shown in Table 7.4-2. The most critical vertical construction joint with regards to shear capacity is the closure joint type 2 connecting tunnel element V and the last part of the tunnel that was constructed together with northern portal building, see Figure 7.4-7. For more details, reference is made to section 6 in Appendix 3 of Longitudinal indicative analyses [9].

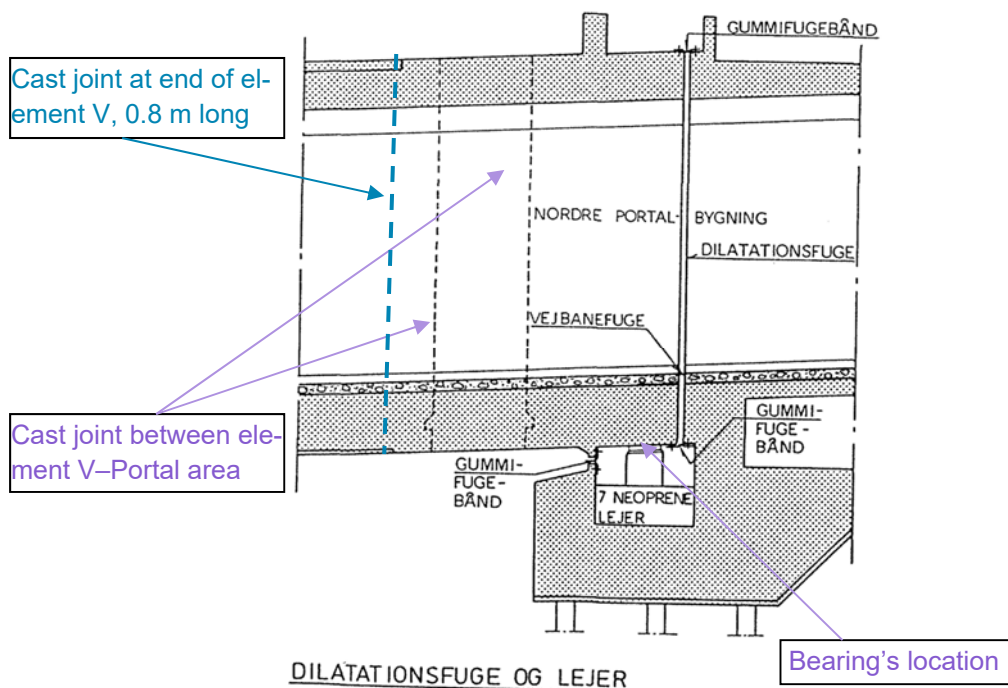

Figure 7.4-7 Geometry of northern end of the tunnel (Closure Joint type 2)

The shear capacities are calculated assuming rough interface, also for the keyed joints because full key cut-off can be assumed.

In the immersion joints type 1, see Figure 4.3-8, between the tunnel elements (immersion joints) additional tension capacity is provided by welded K35/125. This provides approximately twice the capacity of the ordinary reinforced sections, which is assumed to be satisfactory to carry the additional “pre-stressing” force in the Gina gaskets plus the external tension force in the cross section, without taking into account the positive effect of post-tensioning.

One concern is that all main rebars in the immersion joint type 1 and closure joint type 2 are welded (butt welds according to the drawings). Because of the risk of poor quality of the welding (poor workmanship) and reduced ductility of the connections it is important that the sections are not fully utilized. According to Table 7.4-2 this is the case.

#### 7.4.6.4 Bearings

The utilization ratios for the bearings are shown in Table 7.4-2. The design capacity of the elastomeric bearings corresponds approximately to the max design reaction forces for bearings in the future scenario, utilization ratio 1,03 assuming a distribution between the walls of 33% - 33% - 33%. Bearings under the outer walls are the critical ones, because only two bearings are placed here compared to three under the central wall. The critical verification is yielding in the steel plates reinforcing the rubber bearings. An increase of the future expected settlements of 50% will increase the utilization ratio to 1,07, compared to a safety factor for the steel of 1,10 and a safety factor of  $1,1 \times 1,25 = 1,38$  for most of the load effects.



It is assumed that steel quality St.50-2 or better has been used, which is a rather ductile quality with high breaking strength (470 MPa) and a high value of elongation at rupture. Therefore, clear signs of overstress of the bearings are expected in case of overload – expansion of the middle part, possibly in all directions and cracks in the rubber. It should be noted that the existing bearings can be inspected and replaced if necessary.

#### 7.4.6.5 Piles

The axial design capacity of piles is calculated to 1950 kN refer Geotechnical Summary Note [5] compared to a required capacity of approximately 1602 kN, which provides a reserve of around 20%, see Table 7.4-2. As the bearing blocks will be sheared following a longitudinal displacement of tunnel element V, longitudinal loads may be transferred from the tunnel to the northern portal structure. Assuming a shear stiffness of 5,5 kN/mm for each of the seven bearing blocks and assuming a maximum longitudinal displacement of 70 mm, the longitudinal load on the pile heads below the portal structure will not exceed 2,5 MN or corresponding to approximately 40 kN/pile (62 piles). In a medium dense to dense sand this lateral load should be well within the allowable pile capacity, cf. [5].

#### 7.4.7 Flooded tunnel

The accidental load case “Flooded tunnel” has been roughly analysed, and the utilization ratios are shown in Table 7.4-2. It seems that the tunnel is almost able to resist the increased sectional forces with reduced partial safety factors  $\gamma = 1,0$  except for the reaction forces on the bearings. The load case will most probably cause increased deformations/settlements that are irreversible due to the substantial increase of the reaction forces on the soil bedding. Further, cracked areas may need repair and bearings may need replacement.

#### 7.4.8 Summary of utilization ratios, longitudinal direction

In Table 7.4-2 The utilization ratios are summarized. Safety factors are applied on both loads and capacities for Ultimate Limit State (ULS), while all safety factors are equal to 1,0 for Accidental Limit State (ALS)

Utilization ratios	Future scenario, 2019 + 50 years: 60 mm, ULS	Future scenario + extra settlements 30 mm: 90 mm, ULS	Flooding, ALS (accidental load case)
Bending moment, sagging	0,85	0,93	~ 1,0
Bending moment, hogging	0,65	0,78	< 1,0
Shear, global	0,79	0,84	~ 1,0
Shear, construction joints	0,71	0,79	< 1,0
Bearings	1,03	1,07	1,33
Piles	0,82	0,85	< 1,0

Table 7.4-2 Utilization ratios, capacity verifications longitudinal direction

The exceedance for the bearings in ULS is not considered critical. In ALS the exceedance means that the steel plates in the bearings will yield, but not break (breaking strength approx. 60% higher than yield strength). However, the bearings will be damaged and shall be replaced afterwards.

## 7.5 Transverse analyses

### 7.5.1 Introduction

In the transverse direction several analyses have been carried out as described in the following reports:

1. Analyses of transverse Properties, refer [12]
2. Assessment of transverse design of Limfjord tunnel, refer [13]
3. Non-Linear FEM Analysis, refer.[14]
4. Shear Capacity of Casting Joints in top slab, refer [15] &. [16]

In the first report, the sectional forces in the tunnel are calculated based on a 2D frame model for different support conditions, i.e. different variations in bedding stiffnesses in transverse direction.

In the second report the capacities of the cross-sections are verified both in serviceability limit state (SLS) with regards to crack width check and ultimate limit state (ULS) with regards to bending and shear capacity.

In the third report, the load carrying capacity of the tunnel is verified by means of an advanced non-linear FE model using the FEM software DIANA, since the verifications using the Eurocode in the second report indicated that shear requirements (especially in the roof slab) could not be met.

In the fourth report the shear capacity of horizontal interfaces between the original structural concrete and the repair concrete layer substituting the deteriorated parts has been verified for the roof.

The analyses are described more in details below.

### 7.5.2 Analyses of transverse Properties

The frame model is made using the software SCIA Engineer (2D plane frame, linear elastic).

The sections in transverse direction have been verified for different types of tunnel sections with different reinforcement layouts along the tunnel. The location of the different types of cross-sections (A, B and C) and corresponding reinforcement layouts (A3, A2, A1, B1, B2; C1) are shown on [Figure 7.5-1](#).

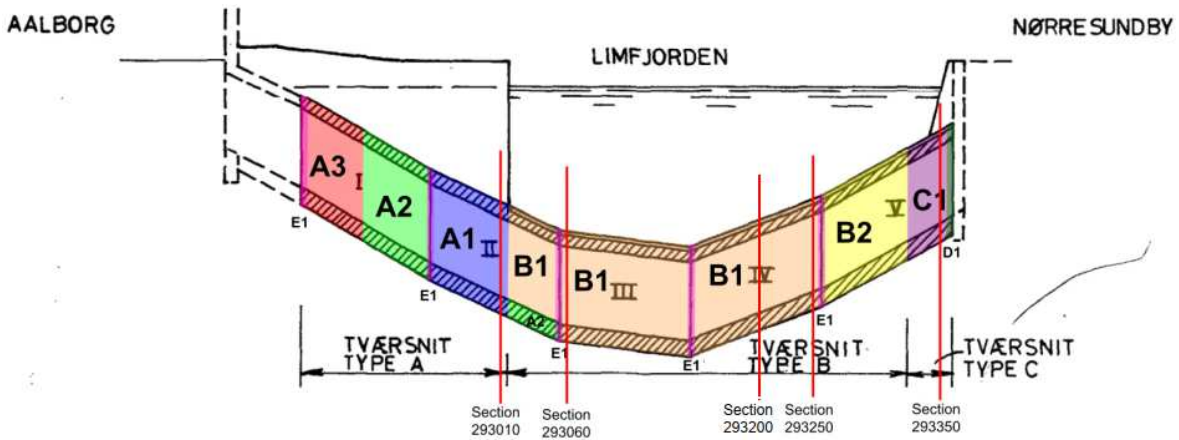

Figure 7.5-1 Locations of cross-sections and types of reinforcement arrangements

### 7.5.2.1 Geometry and sectional properties

The geometry is accordance with the as-built drawings. The reference model corresponds to cross-section B, see Figure 7.5-2.

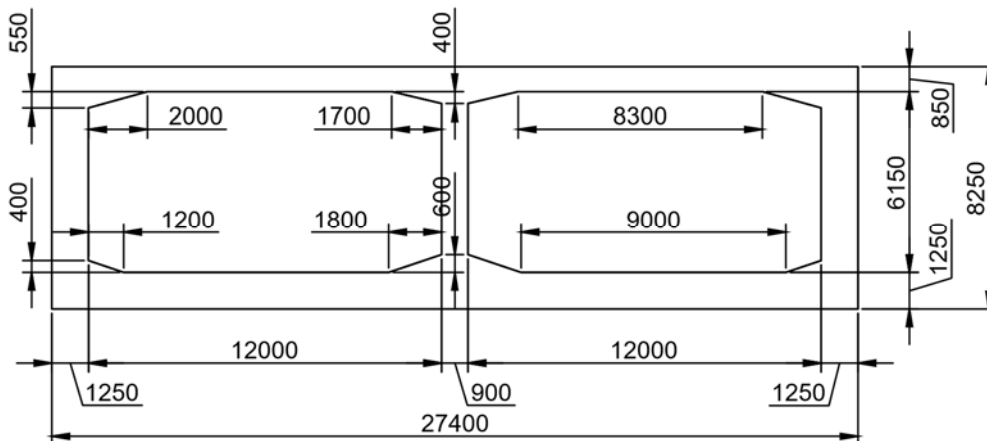

Figure 7.5-2 Dimensions of cross-section, type B

The concrete properties have been assumed to correspond to C20/25. Outer walls, roof and floor slabs are modelled as cracked concrete using a reduced stiffness of 1/3 of the original stiffness. The central wall is modelled as uncracked.

### 7.5.2.2 Support conditions

Spring supports are used for the bedding. In the base case of the reference model a uniform spring stiffness of 2 MN/m<sup>2</sup> has been used, although over the length of the tunnel there is a variation in the spring stiffness. However, the sensitivity of the tunnel cross section regarding the variation as observed along the tunnel action is very limited. Variation of the spring stiffness in transvers direction has a larger effect

The influence on the sectional forces depending on the variation in support conditions in transverse direction have been analysed by, amongst other means by looking at following cases:

- Reduced bedding stiffness  $K= 50\%$  of the outer parts ( $1/4$  of the width), stiffness  $K=100\%$  in the middle part ( $1/2$  of the width). Various values of  $K$  have been considered: 1, 2 and 5  $\text{MN/m}^2$ .
- Reduced bedding stiffness  $K= 100\%, 50\%, 10\%$  and  $0 \%$  on the outer 3m in both sides.

The above cases are considered to give the range of likely stresses in the tunnel cross section.

### 7.5.2.3 Results

For the most critical part, the roof, the influence of the variation of the bedding stiffness is not significant.

The shear and bending moment diagrams for ultimate limit state, ULS, are shown for the most critical section (293060) in [Figure 7.5-3](#). The location of the section is shown on [Figure 7.5-1](#).

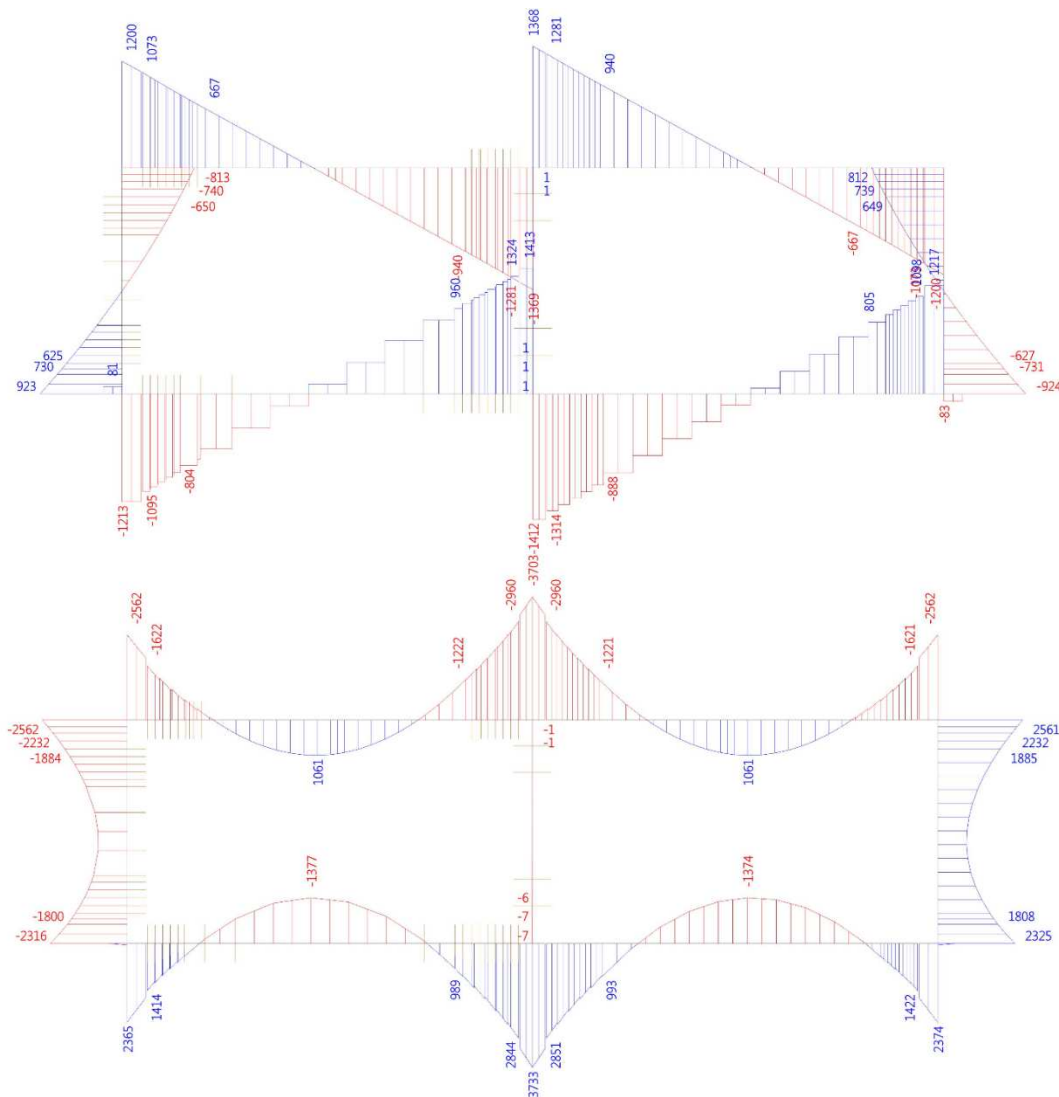

**Figure 7.5-3** Shear force and bending moment diagrams, ULS, section 293060

### 7.5.3 Capacity verification

Checks have been carried out comparing the capacities with the sectional forces calculated by the SCIA-model, described above. Only permanent loads (self-weight, hydraulic and ground loads, dead loads) have been considered, representing most of the loads (>95%). For potential additional load effects, 10% has been added to the sectional forces, which is considered conservative.

All capacities are calculated in accordance with DS/EN 1992-1-1 including DK NA.

#### 7.5.3.1 Properties

Following material strengths, E-modulus and partial safety factors are used in the verifications:

- Concrete compressive strength:  $f_{ck} = 25$  MPa
- Partial safety factor, compressive strength and modulus of elasticity:  $\gamma_c = 1,45$
- Partial safety factor, tensile strength of concrete:  $\gamma_c = 1,70$
- Yielding strength of reinforcement: 410 MPa
- Partial safety factor reinforcement:  $\gamma_s = 1,20$
- E-modulus: 6.000 MPa

#### 7.5.3.2 Results

The results are shown in [Figure 7.5-4](#).

Section	Bending moment, ULS			Crack width, SLS			Shear, ULS		
	Roof	Wall	Floor	Roof	Wall	Floor	Roof	Wall	Floor
<b>293010</b>	0,78	0,53	0,98	0,55	0,32	1,01	0,77	0,48	0,65
<b>293060</b>	0,87	0,51	0,99	0,81	0,31	1,07	1,66	0,46	1,09
<b>293200</b>	0,88	0,58	0,90	0,86	0,34	0,90	1,63	0,41	0,79
<b>293250</b>	0,74	0,48	0,76	0,65	0,26	0,66	1,35	0,35	0,84
<b>293250 3p</b>	0,64	0,45	0,84	0,51	0,28	0,80	1,24	0,50	0,65
<b>293350</b>	0,41	0,28	0,73	0,32	0,19	0,64	0,86	0,29	0,62
<b>293350 sed</b>	0,63	0,42	0,76	0,51	0,24	0,66	1,13	0,29	0,57

**Figure 7.5-4 Utilization ratios crack width, bending moment and shear capacity verification, transverse direction, Location of the Sections, refer Figure 7.5-1**

For crack width control in SLS, the max allowable crack width is 0,20mm corresponding to exposure/environmental class EA (extra aggressive). It is seen from the figure that the crack width limit is fulfilled for almost all cross-sections and only slightly exceeded in few sections.

While the bending moment capacities in ULS are satisfactory for all cross-sections, the shear capacities are exceeded with the highest utilization ratios in a section with distance approximately 1,7m from the face of the central wall, where the bent-up rebars are stopped. The arching action for the non-shear reinforced sections closest to the support has been considered in accordance with the rules in the Danish national annex DK NA to DS/EN 1992-1-1.

#### 7.5.4 Non-linear analyses by FEM software

Due to the significant exceedance of the shear capacities it was decided to calculate the ultimate carrying capacity of the tunnel section by means of more realistic and more advanced non-linear elastic analyses using the FEM (Finite Element Model) software DIANA and carry out the verification according to the State of the Art FIB ModelCode 2010.

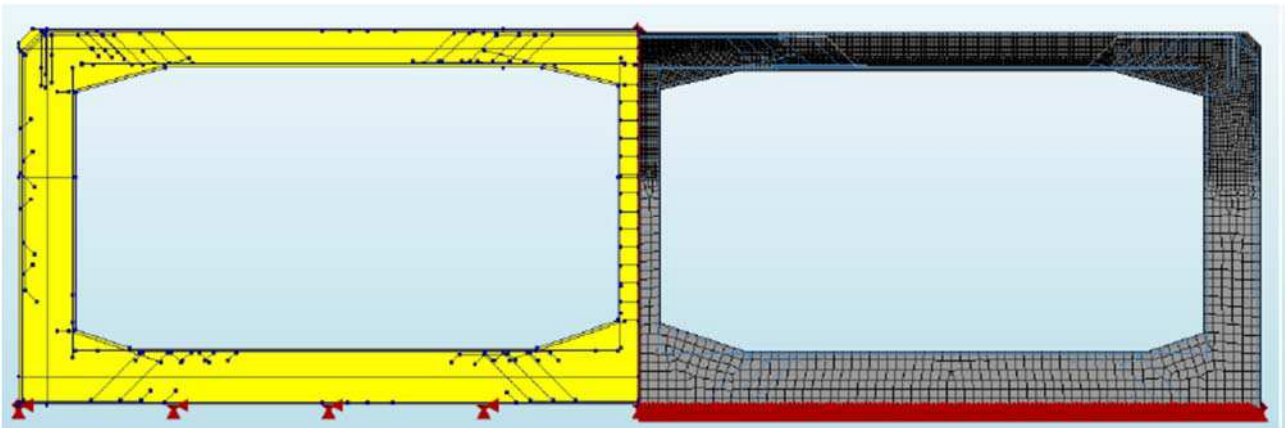

Figure 7.5-5 Modelling every single rebar and applied FE Mesh

The FEM software package DIANA (Displacement ANAlyzer) is able to simulate the structural, physical non-linear behaviour of the reinforced concrete structure. In the nonlinear analysis the total load combination (ULS) is applied using a force-controlled application of loads. This means that the total load is applied incrementally with small steps of about 1% from the moment that the structure starts to behave non-linear, so when the first cracks are initiated. Increasing the load until the structural collapse will determine the capacity in terms of a Load Factor over the total load combination. The Load Factor defines failure of the structure (above the ULS mean load factor of 1,38) as well as the safety level that is present in the structure.

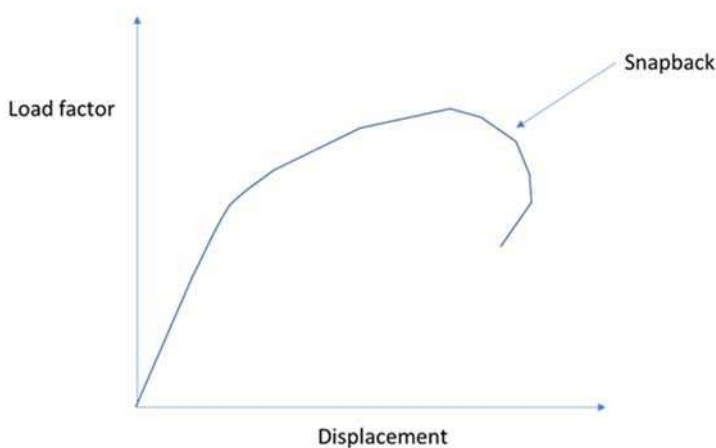

Figure 7.5-6 Load factor displacement diagram



#### 7.5.4.1 Assumptions

The partial safety factor method has been used, which means that safety factors have been applied to both loads and material strengths. For the Base Case the material strengths and partial safety factors listed in Section 7.5.3.1 have been used. These material properties comply with the original design starting points.

The fracture energy defined in FIB Model Code for Concrete Structures 2010 has been used and transferred into a characteristic value, which has been applied the same safety factor as for the concrete compression strength.

The capacity is calculated for section 293.060 and considering the Ultimate Limit State (ULS load factor  $1,1 \times 1,25 = 1,38$  included).

It is assumed that the sections are intact, i.e. full interaction between original and repair concrete is assumed (also see Section 7.5.5, that confirms that this assumption is justified).

#### 7.5.4.2 Results

The analyses have been carried out after the material models have been validated based upon back analysis of real experiments and after sufficient testing the FE model for the tunnel cross section. For the Base Case the load factor is calculated to 1,35. This is in fact additional to the Ultimate Limit State and actually represents a “safety level” of  $1,38 \times 1,35 = 1,86$ . The corresponding crack patterns and deformation plot are shown in Figure 7.5-7.

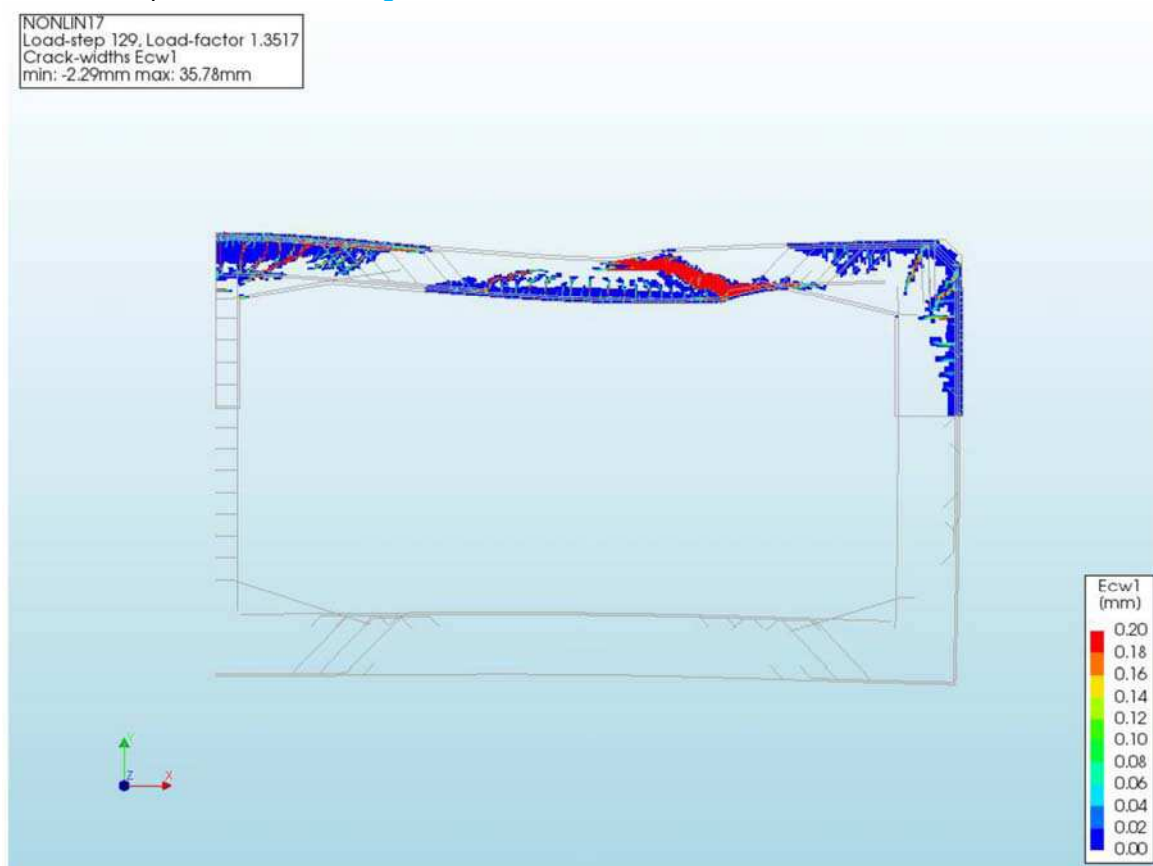

Figure 7.5-7 Base case. Crack patterns at max load level

It is seen that the critical section is close to the outer wall, where the haunched section and bent-up rebars start, and not as expected from the previous calculations the non-shear reinforced sections closest to the central wall. It should be noted though, that the crack patterns indicate that this section is close to be critical as well.

Several additional analyses have been undertaken to examine the sensitivity of the structure to the assumptions. The analyses are indicated in the table below including the achieved Load Factors and "Safety" Levels.

CASE	Load Factor	"Safety"	Explanation
Base Case	1,35	1,86	
Impact of reinforcement variation (reduction)	1,24-1,09	1,71 / 1,50	30% reduction, removing 1-3 bent-up rebars
Effect of higher concrete strength (compliant with actual and recent lab test results)	1,60	2,21	Concrete strength 40N/mm <sup>2</sup>
Impact variation Fracture Energy	1,10-1,54	1,52 - 2,13	Parameter that describes the performance of structure during development of cracks (0,5 * and 2,0 * the most likely value)
Impact reduction of relieving forces	1,35	1,86	50% reduction of axial force in roof slab
Impact of foundation support	1,42 / 1,45	1,96 / 2,00	Bedding 50% over 3m from outer wall / 200% over outer half of the cross section

Figure 7.5-8 Sensitivity analyses and results.

From the table it can be concluded that the effect of an increased concrete strength  $f_{ck} = 40$  MPa is quite substantial with a Load Factor of 1,60. Considering the results of the condition assessment (Section 6.2) it is concluded that considering this increased concrete strength is reasonable and in fact provides a better prediction of the actual safety of the structure.

Several other cases e.g. considering a reduction of the reinforcement has been considered. These analyses identify robustness for any future corrosion scenarios. From the results it can be concluded that the structure under very adverse assumptions still performs with Load Factors from 1,09 to 1,24.

Due to the fact that with the Non-Linear Elastic Analyses the structure is modelled in a more realistic way, there is "less hidden" spare capacity than in a simpler Linear Elastic model. For that reason, a higher "safety level" between 1,8 – 2,0 would be appropriate (Load Factor 1,3-1,4) for the Base Case and the case considering the increased concrete strength. Obviously, for other analyses considering a (significant) reduction of rebar or exploring an extreme bandwidth of parameters (such as in Fracture Energy variation) much lower safety levels are acceptable.

With the advanced Non-Linear analyses and verifications following a more State of the Art Design Code (Model Code 2010) it could be demonstrated that the structure still meets the various design requirements. The various additional analyses have shown that the structure can handle variations in critical parameters very well. The study and the results have been reviewed by an expert of the Technical University of Copenhagen.

### 7.5.5 Assessment of interface between original and repair concrete of the roof

In 1998 comprehensive concrete repairs were carried out in The Limfjord Tunnel. Chloride infected areas in the tunnel ceiling and the walls were removed by water jetting. Corroded reinforcement was replaced, and new concrete was cast to replace the removed concrete. In case of any voids, these were injected.

During inspections carried out in 2007, indications of delaminations and water pockets were found in the repaired areas especially in the tunnel ceiling.

In case of significant delamination of a large area the repair concrete and reinforcement may not contribute to the bearing capacity as anticipated. Approximately 32.500 anchors were therefore installed in 2010 - 2012 in the ceiling to secure the connection between the original concrete and repaired concrete. This due to the fact that calculations showed that the load bearing capacity was insufficient, if more than 71 mm of concrete was disregarded. It is therefore vital that the anchors are functioning as assumed.

The shear capacities of the horizontal interfaces between the original concrete and the repair concrete have been verified using two slightly different methods:

1. Section 6.2.5 in DS/EN 1992-1-1 including DK NA (Eurocode)
2. Section 6.3.4 in fib Model Code 2010

The main difference between the two methods is that the method in the Model Code includes a certain contribution from dowel action, which is more realistic and may be relevant for the sections of the tunnel roof, where anchors have been installed.

Where anchors are not installed, the capacity solely depends on the cohesion contribution. In this case the cohesion coefficient,  $c$ , should be conservatively estimated.

The investigations were carried out according to the number of anchors that were originally designed to be installed (in the following called "designed anchors") and the number of anchors that were actually installed (in the following called "installed anchors"). The actual number of anchors installed in tunnel element V cannot be found. Therefore, the investigations for element V is only based on the designed anchors for this tunnel element.

#### 7.5.5.1 Shear capacity according to section 6.2.5 in DS/EN 1992-1-1 including DK NA

The shear capacity is in general insufficient when only the anchors are considered to contribute to the shear capacity. Overutilization up to 3,06 have been identified.

Therefore, calculations have been carried out to estimate the needed contribution from cohesion to obtain a utilization that is less than 1,0. For the majority of the areas a contribution of 25% of the theoretical cohesion is sufficient to fulfill a sufficient shear capacity, whereas for a few zones a contribution of 50% is needed from cohesion.

An example of calculated utilization ratios in element III according to installed anchors are shown in [Figure 7.5-9](#) and the additional capacity needed from cohesion when 25 % cohesion is taken into account are shown in [Figure 7.5-10](#).

Eurocode - Installed anchors, Utilization  
 Utilization,  $UR_{\text{install}}$ , for installed anchors - Rough surface  
 No normal forces acting on the interface  
 $k_c = 0,00$

Module	1-2	2-3	3-4	4-5	5-6	6-7	7-8	8-9	9-10	10-11	11-12	12-13	13-14	14-1
Cross section	B													
Length	10800	3800	10800	3800	10800	3800	10800	3800	10800	3800	10800	3800	10800	1800

Width	1-2	2-3	3-4	4-5	5-6	6-7	7-8	8-9	9-10	10-11	11-12	12-13	13-14	14-1
1700	0,81	0,85	0,95	0,65	1,90	0,79	0,98	0,76	1,90	0,79	1,90	0,71	0,98	0,34
3600														
3600	0,68	0,63	0,71	0,72	1,07	0,71	0,76	0,71	1,07	0,73	1,07	0,71	0,78	0,33
3100	1,91	1,87	1,99	2,20	2,61	1,87	1,44	1,80	2,77	1,83	2,64	1,87	1,44	1,00

Width	1-2	2-3	3-4	4-5	5-6	6-7	7-8	8-9	9-10	10-11	11-12	12-13	13-14	14-1
3100	2,07	2,25	1,97	2,20	2,91	2,06	1,14	1,83	2,85	1,98	1,44	1,77	1,47	0,88
3600														
3600	0,76	0,86	0,66	0,83	1,03	0,80	0,77	0,89	1,18	0,75	0,81	0,71	0,84	0,37
1700	0,85	0,74	0,82	0,88	1,85	0,74	1,08	0,88	1,90	0,71	0,98	0,71	0,98	0,34

Figure 7.5-9. Installed anchors - Utilization for Element III, west and east tunnel. Red areas indicate utilization higher than 1,0.

Eurocode - Installed anchors - Capacity needed, measured in percent, from cohesion to fullfill utilization = 1,0,  $k_c = 0,25$   
 Calculated from designed anchors (since there are no data from installed anchors from the contractor for this element)  
 Rough surface  
 No normal forces acting on the interface

Module	1-2	2-3	3-4	4-5	5-6	6-7	7-8	8-9	9-10	10-11	11-12	12-13	13-14	14-1
Cross section	B													
Length	10800	3800	10800	3800	10800	3800	10800	3800	10800	3800	10800	3800	10800	1800

Width	1-2	2-3	3-4	4-5	5-6	6-7	7-8	8-9	9-10	10-11	11-12	12-13	13-14	14-1
1700														
3600														
3600														
3100	8%	8%	10%	13%		8%		6%		7%		8%		

Width	1-2	2-3	3-4	4-5	5-6	6-7	7-8	8-9	9-10	10-11	11-12	12-13	13-14	14-1
3100	11%	14%	9%	13%		11%		7%		10%		5%		
3600														
3600														
1700														

Figure 7.5-10. Element III installed anchors and 25% of the theoretical cohesion is taken into account. The numbers indicate the additional capacity needed from cohesion to fulfil a utilization of 1,0.

It must be noted that if a zone is overutilized, it does not necessarily apply to the whole area within the zone but only to the most critical area within the zone.

### 7.5.5.2 Shear capacity according to section 6.3.4 in FIB Model Code 2010

The results from the alternative calculation method in accordance with section 6.3.4 of Model Code 2010 show in general satisfactory capacities also for the case with only 50% contribution from the concrete

An example of calculated utility ratios in element III are shown in [Figure 7.5-11](#).

Fib model code - Installed anchors, Utilization  
Utilization,  $UR_{\text{install}}$  for installed anchors - Rough surface

Module	1-2	2-3	3-4	4-5	5-6	6-7	7-8	8-9	9-10	10-11	11-12	12-13	13-14	14-1
Cross section	B													
Length	10800	3800	10800	3800	10800	3800	10800	3800	10800	3800	10800	3800	10800	1800

Element III - West	Width														
	1700	0,32	0,33	0,34	0,30	0,40	0,32	0,34	0,31	0,40	0,32	0,40	0,31	0,34	0,22
	3600	0,39	0,37	0,40	0,40	0,47	0,40	0,41	0,40	0,47	0,40	0,47	0,40	0,41	0,26
	3100	0,76	0,76	0,77	0,80	0,51	0,76	0,45	0,75	0,52	0,75	0,51	0,76	0,45	0,59

Element III - East	Width														
	3100	0,78	0,80	0,77	0,80	0,52	0,78	0,42	0,75	0,52	0,77	0,45	0,74	0,45	0,55
	3600	0,41	0,43	0,38	0,42	0,46	0,42	0,41	0,44	0,49	0,41	0,42	0,40	0,43	0,28
	1700	0,33	0,31	0,32	0,33	0,39	0,31	0,35	0,33	0,40	0,31	0,34	0,31	0,34	0,22

Figure 7.5-11. Installed anchors – Fib model code - Utilization for Element III with 50% contribution from the concrete.

The low utilizations from the fib model code compared to the Eurocode approach stems from the fact that interlocking between the interface of concrete cast at different times (which it is considered to be the case for the Limfjord Tunnel) has been included in the load bearing capacity and added to the load bearing capacity from anchors including dowel effect.

### 7.5.5.3 Interface/cohesion assessment

From concrete cores taken out during the condition assessment on site it is found that in limited areas the interface might be delaminated. On the other hand, the interface can be considered as rough because the interface is evidently rather uneven. If no delamination was seen the required capacity would be met in all areas.

From the condition assessment carried out as part of this project, it is found that at least 50% cohesion is available in the cores, indicating that the load bearing capacity in the construction joint is sufficient, cf. [Table 6.3-1](#).

### 7.5.5.4 Condition assessment

To secure that the shear capacity will be fulfilled in the years to come, regular inspections must be carried out.

Further, areas without anchors must be inspected for delamination on a regular basis. If delamination is developed in these areas, anchors must be installed.

## **7.6 Conclusions**

The results of the structural analyses with regards to the structural safety can be summarized as follows.

### **7.6.1 Longitudinal direction**

It has been verified that the tunnel has adequate resistance with satisfactory margins to carry the increased loads because of the on-going settlements and to cover the uncertainties related to the estimates. However, an increase in the tensile stresses might be expected in the future because of the on-going settlements leading to more leakages.

### **7.6.2 Transverse direction**

It has been verified that the tunnel has adequate resistance to carry the loads in transverse direction with satisfactory margins taking into account the uncertainties related to the input to the advanced non-linear FE model and to the repaired parts of the roof where both concrete and reinforcement have been replaced.



# 8 Basic Maintenance and Repair Strategy

## 8.1 Introduction

The Basic Maintenance and Repair Strategy is basically a "business as usual" -strategy supplemented by a number of additional activities recommended by the Expert Group. Only one strategy is considered, but this strategy comprises a number of recommended activities. This Section 8 of the Technical Summary Report is based on [18].

The Basic Maintenance and Repair Strategy for the Limfjord Tunnel contains recommendations for the coming 50 years concerning major maintenance, repairs and refurbishment. The recommended activities are to be seen as supplementary to the standard O&M-activities continuously going on in the tunnel. The recommendations in this section are based on input from inspections undertaken in 2018-2019 and input from the Structural Expert Group.

The basis for the standard O&M activities are the activities that are identified in the 10-year plan for the Limfjord Tunnel as is the case for all other major tunnels and bridges administrated by the Danish Road Directorate.

The Basic Maintenance and Repair Strategy (BMRS) is quite complex for the following main reasons:

- The BMRS is a continuous strategy that must be planned for the following 50 years.
- It may be difficult – especially for the repair activities – to foresee when they will need to be implemented – as it is difficult in details to foresee how the condition of the different parts of the tunnel will develop.
- The BMRS – in combination with the basic O&M-activities – contains several activities that are interrelated and influence each other.

The goals of the BMRS are the following:

1. First priority: Maintain the current condition
2. Second priority: Decrease (cause of) deterioration
3. Third priority: Monitor rate of/change in deterioration.

The activities in the BMRS are divided into four main groups under the following headings:

- Inspection and monitoring
- Preventive maintenance
- Repair and refurbishment
- Recommendations from the Structural Expert Group

## 8.2 Actions recommended

The structural assessments carried out by the Structural Expert Group has resulted in a number of recommended activities to be part of the Basic Maintenance and Repair Strategy. The recommended activities include:

- Measurement of settlements and movements of the tunnel by for example fibre optics. This will give a reliable warning related to an increased rate of settlements and possible development of localized axial movements in e.g. a casting joint which could indicate yielding reinforcement
- Measurement of the bearing load at the northern portal building by temporary jacks for instance every 15<sup>th</sup> year. This will give a confirmation of some of the key assumptions related to the structural analysis and assessment in the longitudinal direction, e.g. free spanning length of tunnel element V and loads from backfill and sedimentation.
- Detailed investigation of grounding ship load and tunnel capacity. This could involve a more detailed risk analysis compared to the risk analysis carried out in [17] and the outcome of this analysis could be that protective measures will be required to protect tunnel element V
- Detailed evaluation of the risk of a flooded tunnel due to water entering one of the tunnel ramps. The outcome could be that flood protection measures will be required around the tunnel portal and ramps.
- Detailed analysis of the need for repair or renewal of fire protection. During the inspections carried out in the Limfjord Tunnel it has been observed that the fire protection is deteriorating in certain areas of the tunnel. Further, it is found that this deterioration of the fire protection is related to and adversely affected by water ingress.
- Detailed evaluation on the implication of removing sedimentation on top of tunnel element V inclusive environmental issues and likely unit weight of future sedimentation material.
- Establish a detailed survey of injection material being injected into the tunnel elements during the period where detailed records from the injection campaigns exist. The survey should if possible include date, location and amount of material. (Historical data)
- It is recommended that grout volumes used during the crack injection campaigns are logged systematically. It is also recommended that grout volumes can be linked to selected tunnel sections to follow trends in the future. (Future data.)

The activities above will supplement the more basic monitoring and inspection activities traditionally carried out in the Limfjord Tunnel.

### 8.3 Inspection and monitoring

The proposed activities included in the Inspection and Monitoring program are summarized in [Table 8.3-1](#).

The proposed program is quite comprehensive and includes both inspections that are to be considered as standard (such as IM01, IM 02, IM06 and IM07) for a tunnel structure and measurements that are considered rather special such as IM10.

Further the proposal involves installation of equipment for continuous monitoring of corrosion of the reinforcement and the moisture content in the concrete structures (IM05).

ID	Issue/Method	Frequency	Extent
IM01	Settlements – manually or by means of optical fibre (when installed)	Yearly / continuously	Whole tunnel (as today)
IM02	Movements at tunnel ends (manual measurements)	Yearly	Both ends (as today)
IM03	Logging of extent of crack injection	Yearly	During yearly injection campaign
IM04	Inspection of critical wall sections at immersion joints and closure joint	Yearly	Immersion joints and closure joint in both tubes – walls only (Visual inspection + crack width measurements where relevant)
IM05	Permanently installed monitoring of corrosion and moisture	Continuously	TE III (4 – 6 places)
IM06	HCP <sup>1)</sup> + break outs	Every 6 years	Selected areas in TE III, IV and V. Spot check in TE I and TE II. (Special attention on transition zones between wet and dry areas.)
IM07	Chloride profiles	Every 6 years	Selected areas in TE III, IV and V based on HCP measurements. Spot check in TE I and TE II.
IM07	Cores for macro analysis and thin sections (analysis should include level of ASR <sup>2)</sup> )	Every 9 years	Selected areas in TE III, IV and V based on HCP measurements and other observations. Spot check in TE I and TE II.
IM08	Visual inspection of bearings + measure geometry of bearings	Yearly	Monitor signs of yielding of steel plates on all bearings (Northern end).
IM09	Determine load on bearings by means of jacks	Every 15 years	All bearings (Northern end) (First time within the coming 1-3 years)
IM10	Visual inspection of the southern movement joint using endoscope through cored inspection holes	Every 3 years	3 – 5 places distributed over the bottom part

**Table 8.3-1 Proposed inspection and monitoring program for the Limfjord Tunnel. TE x = tunnel element I to V.**

<sup>1)</sup> HCP (= half-cell potential) is an (almost) non-destructive test method that is used to assess the risk of corrosion of reinforcement.

<sup>2)</sup> ASR = Alkali Silica Reactions.

## 8.4 Preventive maintenance and repair

The major preventive maintenance and repair activities foreseen for the structures are the following:

### Crack injection

Crack injection is a preventive maintenance activity that has been going on for a number of years already. The injections are carried out once a year – usually in December. The work is carried out in the night time during an ordinary tunnel closure. The main purpose of the injection scheme is to stop active leakages. The work is quite effective over a longer period of time, which means the injection only has to be carried out once a year.

It is recommended by the Structural Expert Group that crack injection continues once a year as long as there is a need. Further, it is recommended that the amount of crack injection is registered for every injection campaign in order to follow the overall development in the injections needed to keep water ingress at an acceptable level.

### Cathodic protection

Cathodic protection is a standard method to stop the development of corrosion of reinforcement. In Denmark this measure has been installed during the past 10 years on a number of the main bridges and tunnels administrated by the Danish Road Directorate.

So far cathodic protection (CP) is not used in the tunnel part of the Limfjord tunnels but it was installed in some areas of the ramp walls some years ago.

As the Limfjord Tunnel is found to have an increased risk of corrosion due the water ingress in the tunnel structures it is foreseen that installation of CP may become relevant within the coming 10 to 20 years. In comparison to traditional concrete repairs the installation of CP has several advantages:

- CP can be installed and put into service before corrosion has caused damage to the concrete.
- CP is quite easy to install in a tunnel where all structures are readily accessible from the inside.
- CP can be installed during standard night closures. Hence, the impact on traffic is quite limited. However, in practice, for a smooth and efficient installation, either the south or north going tube must be closed for installation.

The main downside of installing CP is that it requires constant monitoring (this can be done almost fully automatically however) and that the electrical parts of CP needs replacement approximately every 15-20 years.

## 8.5 Trigger values

In order to know when follow up is needed on the monitoring activities, trigger values have been defined for a number of key parameters included in the monitoring activities.

The background for the trigger values are described in Section 8.5.1 trough Section 8.5.3. In Section 8.5.4 an overview of all the trigger values is given.

### 8.5.1 Total settlements

In general, satisfactory spare capacities in the ultimate limit state (structural safety) are found for all verifications in the longitudinal and transverse directions.

The increase in sectional forces in the longitudinal direction is caused by the settlements. However, in case of bigger future settlements than expected the increase is moderate. An increase in settlement of approximately 50% (+30mm) in addition to the predicted future settlements from 2017 to 2069 of 60mm is still within the acceptable limits of the ULS structural capacity in the longitudinal directions.

Since the post-tensioning cannot be considered as internal fully embedded an extra safety margin should be considered. This extra safety margin is covered by the structural assessment in Section 7.4, where the above-mentioned increase in settlement of 30mm has been taken into account.

The link between the total settlements and the ULS capacity along the tunnel alignment can then be expressed through the following guidelines:

- Green area on [Figure 8.5-1](#): ULS capacity is OK
- Yellow area: The ULS capacity of the tunnel structure is OK but the vertical load on the bearing blocks shall be measured and the longitudinal analyses shall be updated ensuring compatibility between total displacements and the load on the bearing block.
- Below yellow area: The ULS capacity of the tunnel structure does not comply with existing regulations.

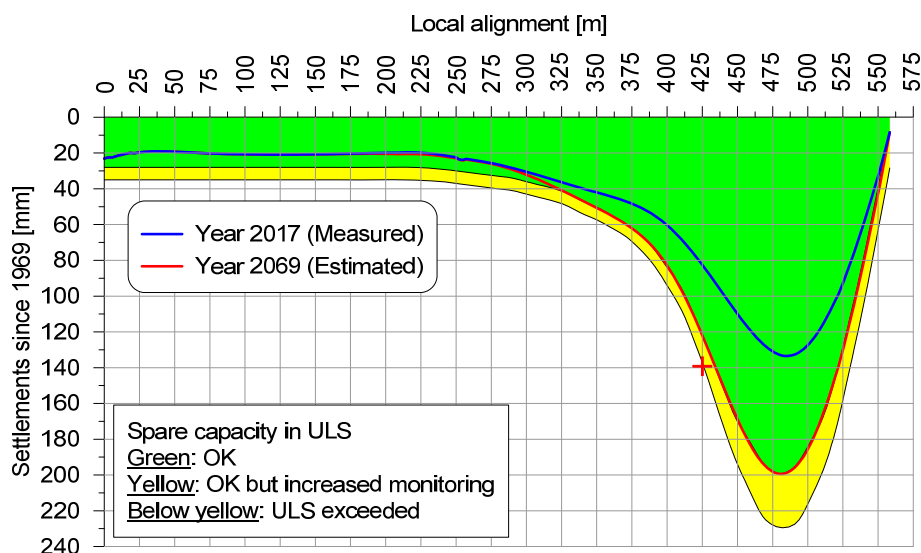

**Figure 8.5-1 Settlements of tunnel structure since 1969. Colour-code relates to whether the tunnel structure complies with existing regulations considering the ULS capacity.**

To be able to adjust and react in time before the total settlement reaches the yellow area in [Figure 8.5-1](#) it is suggested to include a maximum settlement rate as a trigger value. The settlement rate could be measured over a period of at least 5 years and it shall be reviewed if it exceeds 3 mm/year.

### 8.5.2 Differential settlements

Limits for differential settlements are included through the maximum allowable inclination of a tunnel section relative to horizontal. A tunnel section may not be inclined more than the “as-installed” inclination from 1969 plus 2.5 mm/m (average value along 10 m), and if the value is exceeded, longitudinal analyses shall be initiated to clarify the consequence. The value of 2.5 mm/m corresponds to the inclination of the lower boundary curve of the yellow zone where the red cross is shown on [Figure 8.5-1](#).

### **8.5.3 Condition monitoring**

A number of key parameters for increased monitoring has been identified. In order to secure timely intervention in case of deterioration of the structural elements of the Limfjord Tunnel a number of trigger values for these key parameters need to be identified.

This section contains a proposal for key parameters to keep under close observation as well as proposals for trigger values for these parameters where remedial actions should be considered. Also associated preventive actions are identified.

### **8.5.4 Key parameters and trigger values - Overview**

All the key parameters and the corresponding trigger values are summarized in [Table 8.5-1](#)



ID	Structural element	Key parameter	Trigger value	Preventive action / Follow-up
TV1	Outer walls and roof (wet areas)	Water content	Degree of saturation < 80 %	Increased monitoring of corrosion
TV2	Outer walls and roof (wet areas)	Corrosion rate	Corrosion rate > 10 $\mu\text{A}/\text{cm}^2$	Increased inspections (HCP + break outs)
TV3	Outer walls and roof (dry areas <sup>1)</sup> )	Chloride content by concrete weight	> 0,05%  > 0,1%	Increased focus on signs of corrosion  Break outs to look for corrosion
TV4	Outer walls and roof (dry areas <sup>1)</sup> )	Corrosion rate	Corrosion rate > 10 $\mu\text{A}/\text{cm}^2$	Increased inspections (HCP + break outs)
TV5	Roof (Areas without anchors)	Delaminations	Signs of delamination	Install supplementary anchors
TV6	Closure joint (Joint type 2 )	Cracks	Visible cracks	Monitor development in crack width. Analyse need for remedial action (lowering of north end).
TV7	Immersion joints and closure joint (Joint type 1 and 2)	Corrosion rate	Corrosion rate > 10 $\mu\text{A}/\text{cm}^2$	Increased inspections (HCP + break outs) – prepare for CP
TV8	Construction joint type 2 and type 1	Corrosion	> 10 % area loss	Cathodic protection (CP)
TV9	TE III, IV and V	Settlements	> 60 mm (from 2019) > 3 mm/year	Analyse need for remedial action (pre-stressing or lowering of north end)
TV10	Bearings	Increased deformations	Signs of yielding of steel plates	Analyse need for remedial action (new bearings)
TV11	Southern movement joint	Corrosion of steel parts	Significant corrosion	Renewal of steel parts or new Omega joint
TV12	Concrete, outside and inside cores	Expansion on concrete samples due to ASR <sup>2)</sup>	Expansion > 0,1%	Follow-up analysis
TV13	TE III to TE V	Extent of crack injection	Increase year-by-year > 20%	Follow-up analysis

<sup>1)</sup> Dry area = Areas where "Degree of saturation" < 80%

<sup>2)</sup> ASR = Alkali silica reactions (Test method: TI-B 51 modified for use on samples from existing structure.)

**Table 8.5-1 Key parameters for monitoring with associated trigger values. The stated trigger values need to be re-evaluated from time to time based on results from inspections.**

## 8.6 Expected repair activities until 2069

The repair activities described below should be prioritized.

### Concrete repairs

Some concrete repairs may be necessary within the next 15 to 25 years.

#### *Closure joints*

The main concern is concrete repairs in the closing joint areas as the structural analyses carried out during the life extension project has shown that the utilization ratios of these areas are quite high. This, combined with possible future corrosion of the reinforcement, may lead to a need for repairs in these areas.

The planned close monitoring of these areas, and the possibility of installing CP, if active corrosion is observed, does however mean that the risk of these repairs becoming necessary is limited. Furthermore, the repairs – if needed – will be limited in extent and size.

#### *Roof*

There is a risk that water pressure will build up at the interface between original concrete and repair concrete as the repair concrete is quite impermeable.

Hence, the implementation of a rather extensive inspection and monitoring scheme is recommended. This scheme in combination with cathodic protection is assessed to be an effective way to prevent significant damages to the roof to develop.

It may be considered to establish a number of weep holes through the repair concrete in order to relieve the water pressure assumed to build up at the interface between repair concrete and the original structural concrete.

#### *Walls*

Due to the constant water pressure a need for repairs may occur on the walls e.g. due to loose tiles or corrosion.

The implementation of a rather extensive inspection and monitoring scheme in combination with cathodic protection is assessed to be an effective way to prevent significant damages developing. Hence, only small, local concrete repairs on the walls are foreseen.

#### *Bearings*

Repair - or most probably – renewal of the existing bearing at the northern end of the immersed part of the tunnel, which may become relevant within 10-20 years, is dealt with in one of strategies of the structural subgroup – see Section 9.3.3.

#### *Movement joints*

The Limfjord tunnel has movement joints at both ends. The layout of the joints is quite different in the two ends.

At the northern movement joint the omega seal, being a vital part of the movement joint, will be replaced in 2019.

The current state of the omega seal in the southern end is currently unknown as it is not readily accessible for inspection. It is recommended that the seal and the adjoining fastening arrangements are thoroughly inspected within the coming year to determine the condition.

It must be foreseen that it will be necessary to repair or replace the southern movement joint within the next 25 years. This project will include demolishing the concrete forming the cover of the joint. This means that this work will have considerable impact on the traffic in the tunnel. Hence, it is preferable that this work can wait till the third Limfjord link has been established in 2030. As long as the current condition is not known it is, however, difficult to assess whether this is a realistic scenario.

A number of aspects do, however, make it reasonable to assume this to be a realistic scenario:

- The joint is placed on land and is subjected to a rather low water pressure,
- only considerable degradation of the joint will cause significant inflow of water,
- there is no reason to believe that the Omega-profile will fail within foreseeable time as this type of profile is known to have a long service life when it is not subjected to overload or critical deformations (which is assessed not be the case).

## 8.7 Conclusions

It is recommended that the ongoing schedule of standard operation and maintenance is continued. A number of additional monitoring activities and regular in-depth inspections are also recommended.

An increased level of monitoring is recommended due to the Limfjord Tunnel being a “high risk” structure. This classification is due to an increased exposure to water ingress and chlorides and the related risk of corrosion, delaminations and other damages.

Due to big load effects, immersion joints and (in particular) the closure joint shall be inspected yearly for signs of overload.

The combination of an increased schedule of inspection and monitoring and the possibility of implementing cathodic protection before significant damages have developed means that no major repairs are expected within the next 10-15 years.

The current state of the movement joint in the southern end of the tunnel needs to be established. Based on for example, Dutch experience there is a risk that the clamping structure of the Omega seal will (locally) need replacement or refurbishment within less than 10 years. This may cause significant disturbance to the traffic as the southern movement joint is placed in a small recess below the roadway and therefore can be reached only by removing the concrete above the joint (obviously depending on the area and location that would need repair / replacement).

The overall maintenance plan must take into account the possibility of a third crossing over the Limfjord within 10 years. This gives the opportunity – when the new connection is open and traffic in the Limfjord Tunnel reduced - to close either north or south running tunnel tube for a longer period in order to make the necessary repairs or strengthening.

# 9 Retrofitting strategies

## 9.1 Methodology

A number of potential retrofitting strategies – close to 20 -have been identified and evaluated by the Expert Group.

The strategies can be grouped as follows:

- Geotechnical strategies
- Structural strategies

The geotechnical and structural strategies were identified to either mitigate the effects of the ongoing settlements in the northern part of the immersed section (element V) or to mitigate the effects of the leakages in mainly the middle part of the immersed section (e.g. elements III and IV). The basic maintenance and repair strategy is focusing on the mitigation of the effects of the leakages in mainly the middle part of the immersed section.

The considered strategies were assessed using an initial screening process. This adopted a quantitatively based assessment of the identified options. One geotechnical retrofitting strategy (settlement mitigation) and two structural retrofitting strategies (leakage and settlement mitigation) were chosen for further development based on the above assessment.

The pre-screening process and the selected geotechnical and structural strategies are presented in further detail in the sections below.

## 9.2 Geotechnical strategies

### 9.2.1 Purpose

The main aim of any geotechnical retrofitting solution is to control or reduce the expected ongoing settlement of the tunnel as described in Section 5 to acceptable limits and/or reduce the geotechnical loading on the tunnel. This would in turn control and reduce the stresses in the tunnel structure. An optioneering process was undertaken to assess feasible geotechnical solutions. This process is described in detail in the background document *Geotechnical Retrofitting Options [6]* and is summarised briefly below.

### 9.2.2 Optioneering process

The optioneering process initially considered a wide variety of possible geotechnical retrofitting solutions that could potentially be undertaken to improve the performance and life of the structure. The solution options were based on typical industry proven ground engineering techniques which could potentially be used in the conditions at Limfjord.

These initial options were pre-screened, and the subsequent feasible options were then assessed in order to determine a preferred option which, would then be assessed in more detail. The assessment of the feasible options considered the performance requirements, constructability, costs and restrictions outlined in the report *Geotechnical Retrofitting Options report [6]*.

Feasible options that were considered are outlined below;

1. *Soil improvement using vertical jet grouting;*
  - Option 1:* Adjacent to the tunnel installed from a jack up rig.
  - Option 2:* Partially under the outer walls installed from a jack up rig.
  - Option 3:* Beneath the tunnel installed from within the tunnel during lane closures.
  
2. *Horizontal grouting installed under the tunnel from cofferdams adjacent to tunnel.*
  - Option 4:* Active compensation grouting inducing a positive lift to the tunnel.
  - Option 5:* Horizontal volume grouting providing soil improvement (Passive)
  
3. *Unloading*
  - Option 6:* Replacing Sand Fill adjacent to the tunnel with lightweight aggregate.
  - Option 7:* Removing soil overburden on element V by dredging.

Based on the optioneering process undertaken the highest scoring solution is option 7, removing the overburden from element V. However, this option has a very low technical score due to the negligible reduction of the settlement and would only be appropriate if the removal of the loading provided the required benefit to the tunnel structure. The total cost for the removing the overburden from element V is expected to be less than €1m.

The next highest scoring option is option 4, the active compensation grouting solution. Although this is one of the more expensive feasible solutions it provides the highest technical performance. This preferred option is the only one considered that could provide a positive temporary lift to the structure reducing the long-term settlement and mitigating the risk of any settlement caused by the installation process. The proposed solution is fully detailed in the geotechnical retrofitting report [7] and is summarised in Section 9.2.3 below.

The likely performance in terms of settlement reduction for many of the other options was considered not to have sufficient benefit for the structure when related to the cost of installation and other risks and issues considered.

### **9.2.3 Preferred Geotechnical Option: Active horizontal compensation grouting**

Compensation grouting is a geotechnical process that is used to control the settlement of structures and can be used to also lift the structure from its present position. The method involves the injection of grout into the ground immediately below the structure which results in an expansion of the soil. This can counteract any settlement that has occurred and can provide a controlled uplift of the tunnel structure to compensate for the predicted future ground settlement (approximately 60mm to 2069).

For the Limfjord tunnel the injection of the grout and control of any induced heave can be carried out from cofferdams located outside of the tunnel structure and hence there would be no significant disruption to the tunnel users. To provide a positive heave of the tunnel, precondition grouting of the Sand Fill will be required below the main compensation grouting area and two rows of horizontal boreholes at separate levels may therefore be required.

Control of the grouting can be very selective inducing very small level changes of varying amounts to reduce the risk of inducing further stress in the tunnel structure. The compensation grouting treatment would be installed from the midpoint of element IV to approximately 25m from the Northern Portal (i.e. 125m long over the full width over the tunnel) as shown in [Figure 9.2-1](#) and [Figure 9.2-2](#).

The basic sequence to undertake the compensation grouting process for Limfjord would involve the following;

1. Installation of a bespoke monitoring system in the tunnel to provide real time structure movement information.
2. Construction of marine sheet pile cofferdams at a suitable distance from the tunnel enabling a drilling and grouting working platform at the required depth approximately 4m below the base of the tunnel. Two cofferdams would be required. A Jet grouted or a concrete base plug and tension piles are likely to be required below the base to resist high water pressures and provide base stability.
3. Installing ship impact protection piles to provide protection to the cofferdams during the grouting process. See [Figure 9.2-1](#)
4. Installing two levels of horizontal grout injection tubes to a pre-determined pattern under the structure. See [Figure 9.2-2](#) and [Figure 9.2-3](#). The drilling techniques to be adopted will address the high water pressures and poor ground conditions that will be present at this level.
5. Injection of pre-treatment and main compensation grout through the grout injection tubes with careful process control to induce required tunnel uplift movements.
6. The tunnel would be monitored for all stages of construction from the installation of the caissons and during the installation of the injection tubes and grouting process.

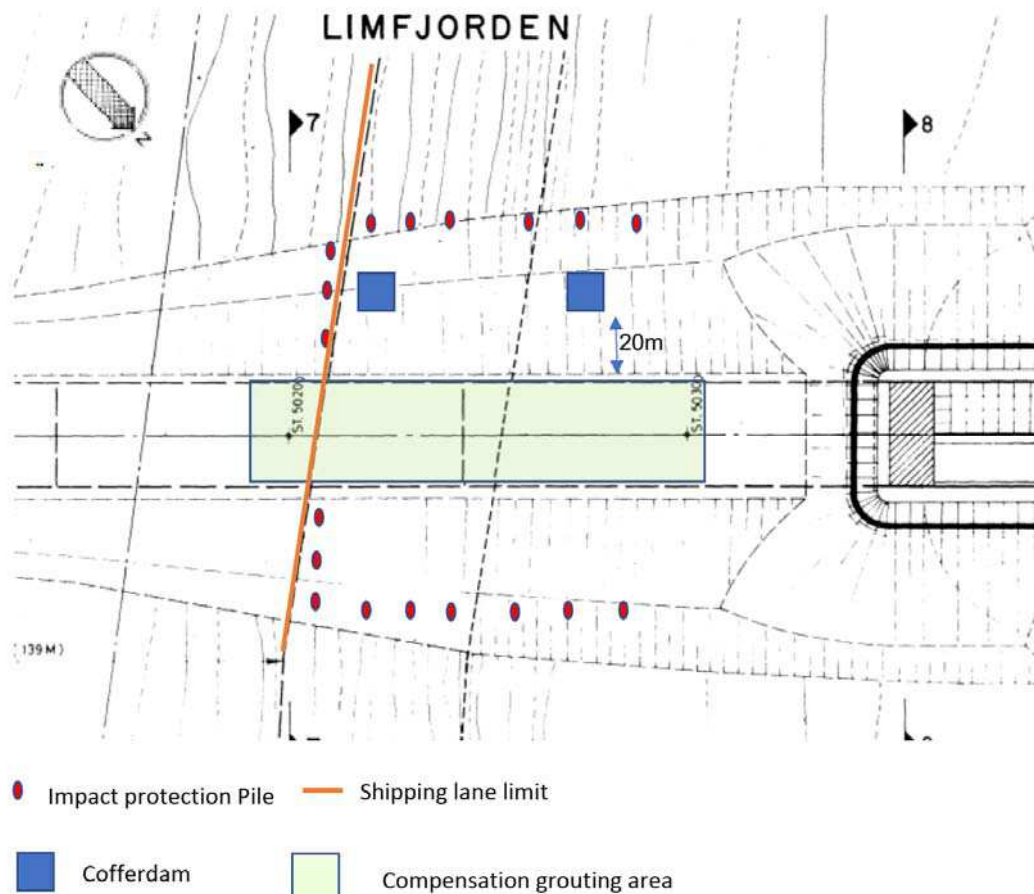

Figure 9.2-1 Indicative plan showing cofferdams and ship protection piles.



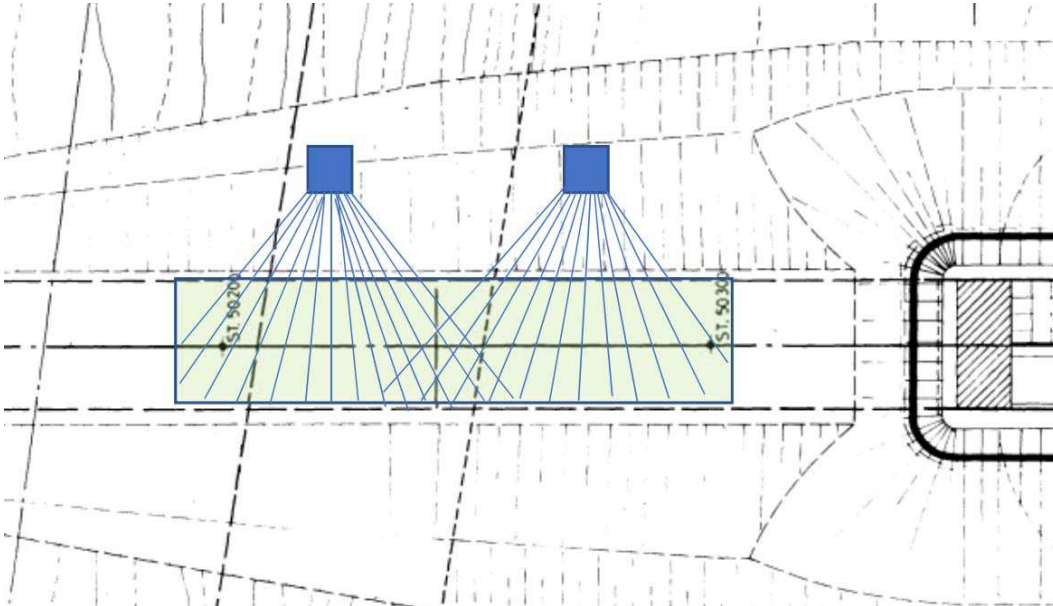

Figure 9.2-2 Plan showing indicative layout of grout injection tubes.

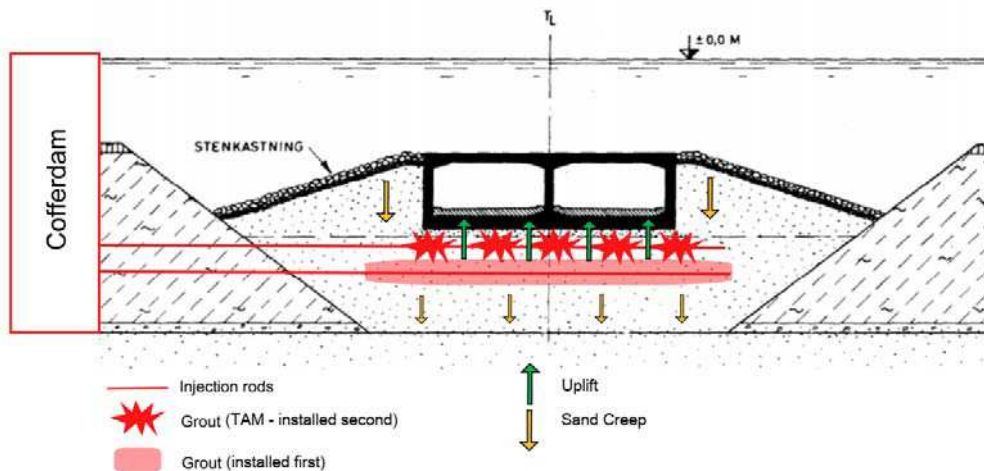

Figure 9.2-3 Section showing indicative pre-treatment and compensation grout injection tubes.

The construction programme is expected to be in the order of 17 months.

Information on the project risks and mitigation measures are also provide in the detailed report [7].

The actual effects on the tunnel structure using this option will need to be analysed and assessed during the detailed design phase but it is expected that the lifetime of the structure will be extended by the option proposed.

## 9.3 Structural strategies

### 9.3.1 Purpose

The structural retrofitting strategies – pre-screening of options - identified 7 numbers of feasible options. Three options were regarding remedial works dealing with defects only related to the structural safety. Investigations have concluded that they are not relevant/necessary. The remaining four options were regarding remedial works dealing with limiting the crack width or close the cracks (tensile stresses) to reduce future leakages, improve durability and limit the extent of the injection campaigns.

The pre-screening of options included a comparison of the feasible relevant options. The scoring system used in this comparison resulted in a ranking of the options where additional prestressing became number 1 and replace bearing blocks became number 2.

### 9.3.2 Additional prestressing

In 1993 – 1994 post tensioning cables were installed in the ballast concrete. A total of 30 cables type Freyssinet 12L15 were embedded in each tunnel tube and the total tension force for the tunnel cross section (at 80 % tension) was 150 MN. The positive effect of this tensioning project has been documented. It has been argued that further tensioning would have been beneficial – up to twice the installed capacity has been mentioned. The additional post tensioning can reduce the tensile stresses and cracking from both seasonal temperature variations and future settlements and thereby increase the durability of the tunnel and reduce the extent of the injection campaigns.

It was chosen to develop a solution which will have minimum disturbance on the traffic in the tunnel and accordingly a solution was developed where additional cables were not placed inside the ballast concrete. Under the tunnel ceiling the space is varying depending on location. In some locations, e.g. where jet fans are located, there is plenty of space, but in other locations there is nearly no space. It has been concluded that cables cannot be accommodated under the ceiling. The only space available for additional cables is along the walls above the diminutive sidewalks. Figure 9.3-1 shows the allowable space for cables with an acceptable distance from any traffic. In the 0.35 m wide and 1.90 m high spaces indicated (blue colour) installations are accepted according to UK regulation (DMRB) and German regulation (RABT). The Danish Road Directorate DRD has confirmed that installations in these spaces are also accepted in Denmark. There will be no interference with (blocking of) any of the emergency doors in the middle wall and cabinets in all the walls.

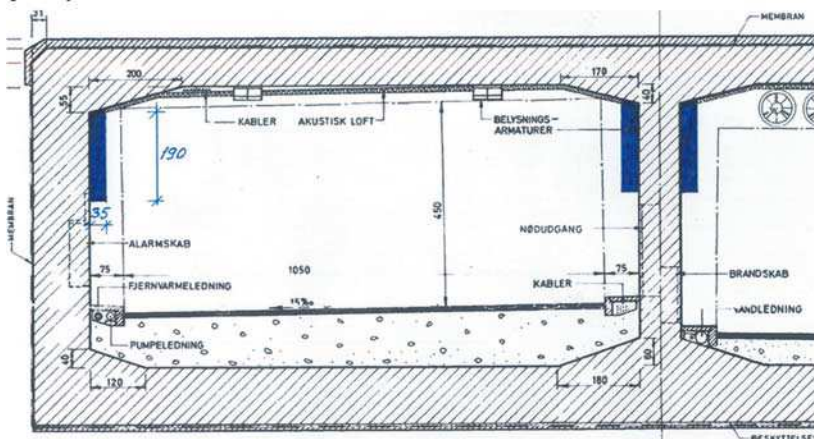

Figure 9.3-1 Spaces available for installations such as external post tensioning cables (blue colour) along upper part of all wall surfaces.

The available spaces are assumed used for placing a number of external post tensioning cables. External cables are often used for strengthening of existing structures and the solution is considered well proven technology even though the use in an immersed tunnel may be unusual.

The cables will be exposed to the risk of accidental damage by impact from vehicles astray and will also be exposed to damage in case of a fire. But as the cables are not necessary for the safety of the structure these circumstances can be disregarded.

The number of cables to be accommodated in the narrow spaces available is of course limited. If necessary, more space for more cables can be provided, e.g. along the middle wall by a certain (minor) reduction of the width of the fast lane. The fast lane is however the slow lane during periods with two directional traffic in one tube, why such reduction cannot be major. It is therefore instead proposed to reduce the width of all three lanes if necessary for providing more space for the cables. A small reduction is not considered a problem by DRD as it has been used in several cases on Danish motorways (one example is on the Kalvebod bridge in Copenhagen).

The external cables can be supplied by companies such as VSL, CCL, BBR and Freyssinet. As an example, Freyssinet explains that the most common use of C range cable system in external prestressing is based on the use of strands placed inside sections of thick HDPE tube, assembled by mirror welding, which are injected with cement grout after tensioning. The use of a grease or wax (a flexible corrosion resistant protective product) instead of cement grout is an alternative. It is however here recommended to use the cement grout due to the possibility of damages from traffic or fire and as it is considered to provide a better protection of the cables in the sometimes wet/humid environment in the tunnel. So that a duct can be removed without damaging the structure, the ducts are of double casing type at deviators and anchor diaphragms. The HDPE tube runs inside a rigid metal lining that separates the tendon from the structure and distributes the transverse loads caused by deviation.

In the Limfjord tunnel the deviators will only be controlling very small angle changes and friction losses will be very small. Considering the circumstances for installation, the anchorage and deviator blocks could be considered as tailor-made steel structures fixed to the existing structure by use of (a large number) of drilled and glued-in anchor bolts. At the middle wall it could be considered to use prestressed bolts and shear blocks or profiles passing through the wall. Anchor and deviator blocks can also be constructed as reinforced concrete structures, but such will probably slightly limit the number of cables compared to a steel solution. The concrete solution can in general benefit from standard components and is therefore not depending on the design of a number of special tailor-made items necessary for the steel solution. Concrete anchor and deviator blocks also depends on a large number of drilled and glued-in anchor bolts and the distribution of forces to the many anchor bolts is more simple in a concrete block compared to a steel bracket type of anchor block.



Figure 9.3-2 External post tensioning cables – intermediate tendon supports (VSL system shown).

The locations for anchor blocks shall allow a stepwise application of the forces into the structure. Some cables in full length and other cables staggered where the tensile stresses are highest. Tension behind the local anchorage shall be considered. The cables considered are very long; each in average 450 m. They are therefore supplied in half length and assembled with so-called moveable couples.

Different solutions for installation of additional cables have been investigated. The preferred solution which has been developed and used as basis for the cost estimate is with concrete anchor and deviator blocks and gives an additional prestressing force of around 80 MN. For further details refer to [10]. During a possible detailed design phase, it is recommended to investigate completely both a concrete and a steel solution in order to compare possible effects to be achieved, necessary space requirements and costs of construction and maintenance.

The installation of cables and anchor/deviator/support blocks shall be executed during a complete closure of the tunnel tube where works are ongoing. In case of steel anchor and deviator blocks the time needed for installation will be somewhat shorter compared to the casting of concrete anchor and deviator blocks. The tensioning of all cables – and the following injection with cement grout – shall be postponed until after installation of all cables to allow a stepwise tensioning – a sequence of steps alternating between west and east tube. It is assumed that installations can be executed during relatively short periods with closure of one tunnel tube (i.e. periods of 4 or 6 weeks of summer holidays) as indicated in Table 9.3-1. The tensioning and grouting can be executed during night closures alternating between tubes or during a weekend where the entire tunnel is closed.

Activity	Period in case of concrete anchor blocks	Period in case of steel anchor blocks/brackets
Initial works west tube	6 weeks	4 weeks
Initial works east tube	6 weeks	4 weeks
Tensioning and grouting west	Nights (alternating between west and east tube)	Nights (alternating between west and east tube)
Tensioning and grouting east	Nights (alternating between west and east tube)	Nights (alternating between west and east tube)

Table 9.3-1 Assumed periods necessary for construction of additional prestressing in tunnel.

### 9.3.3 Replace bearing blocks

The bearing blocks located in the northern portal building are dimensions 706 x 756 x 146 mm<sup>3</sup>. The thickness of the grout pad under the bearing blocks is approximately 40 mm.

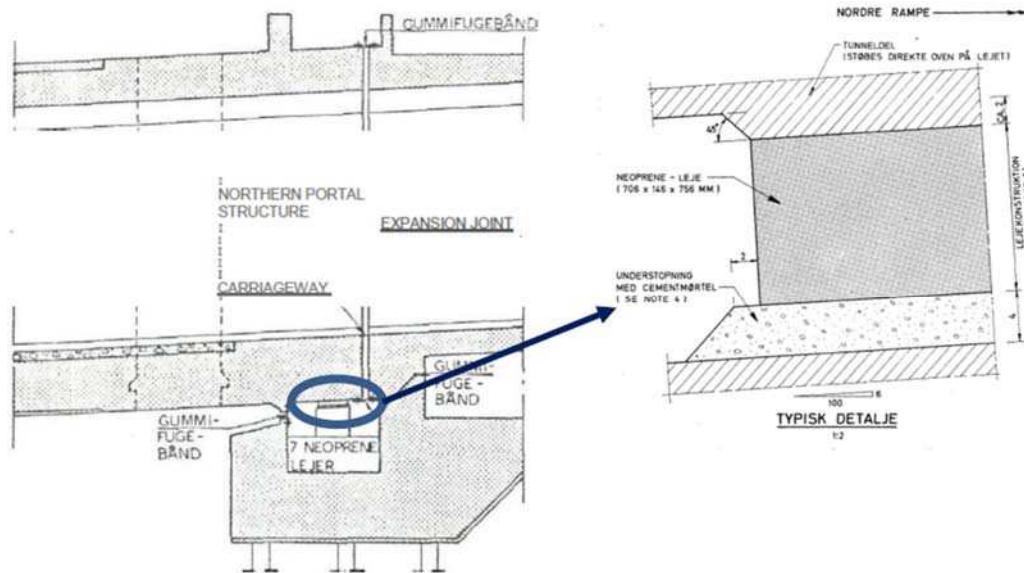

Figure 9.3-3 Existing bearing blocks in northern portal building.

These bearing blocks can be replaced with new bearing blocks with less height and with a Teflon layer included. The possible reduction in height may not be more than approx. 20 mm, but more lowering can be achieved by a small reduction in the height of the plinths below the bearing blocks. The height of the grout pad can also be reduced from 40 mm to approximately 20 mm. The possible lowering of the northern end of tunnel element V is thus at least say 90 - 100 mm (but circumstances as explained in the following may prevent such a big vertical displacement unless some special measures are introduced).

The use of bearing blocks with a reduced height would close the potential gap under the northern end of the tunnel to some extent. Thereby more ground support could be mobilised and forces/stresses in the tunnel in the longitudinal direction could be reduced. If the capacity of the cross section in the longitudinal direction was exceeded in the remaining lifetime (not assumed) this could be a relevant remedial proposal. But the proposal will also have some beneficial effect on limiting the crack width or closing the cracks (by decreasing tensile stresses) to reduce future leakages, improve durability and limit the extent of the injection campaigns. The new bearing blocks could be installed with load cells providing current information regarding the load transfer and thereby be an important element in the future monitoring of the tunnel structure (trigger values).

Temporary jacks would be used to exchange the bearing blocks and during this operation to provide information regarding the current load and indirectly regarding the potential gap and the foundation bed mobilization. The jacks could also be used as part of the monitoring system.

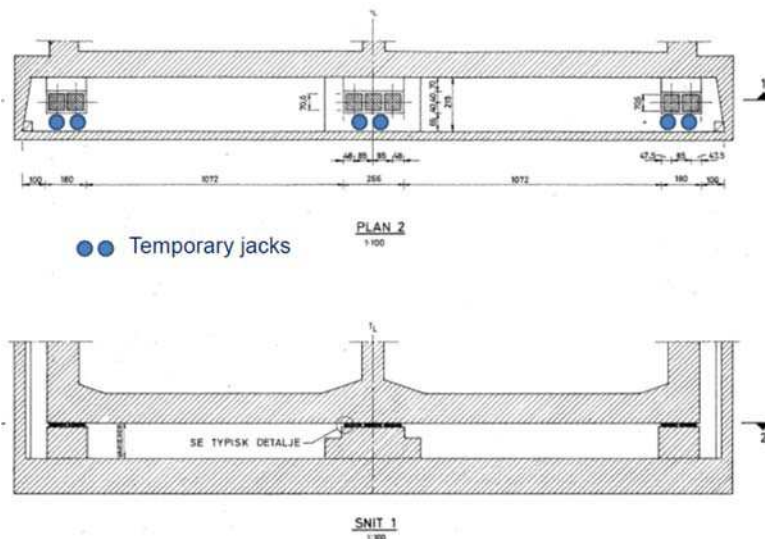

Figure 9.3-4 Location of temporary jacks during replacement of bearing blocks.

The temporary jacks can only be placed south of the bearings in the gap between the small front wall with the Omega seal expansion joint and the plinths. It means that the loads on the piles will be applied eccentrically.

Replacement of bearings by use of temporary jacks is often used, however mainly on bridges. It must be regarded as well proven technology even if it is not common practice in case of an immersed tube tunnel.

At least two important issues must be considered when deciding a possible reduced height of the bearing blocks. The existing Omega seals can probably not adopt the maximum possible vertical displacement equal the lowering of the tunnel. The Omega seals will probably define a too narrow limit for this vertical displacement and as this is not assumed to provide enough effect, a radical new Omega seal solution must be developed. The expansion joints in the road surfaces can without doubt also not adopt the maximum possible vertical displacement and the installation of new expansion joints in the road will influence the traffic. Even a minor vertical displacement may result in the construction of some wedge-shaped transitions in the asphalt.

The replacement of the bearing blocks may be executed without much effect on the availability of the tunnel. It must however be considered if load transfer from bearings to jacks and vice versa is considered critical in respect of safety for the tunnel users. But these operations can maybe be executed during only night or weekend closures of the tunnel (the entire tunnel). The new Omega seal solution can be executed without any (or much) influence on the traffic. New expansion joints in the road surfaces will probably require the closure of each tunnel tube for approximately a week. New wedge-shaped transitions in the asphalt can be executed in parallel during such week. As the vertical displacement of the tunnel end will happen “over-night” some temporary transitions in the road surfaces will be necessary (together with a reduced speed of vehicles during the period).

The cost estimate prepared for this solution attempts to include for a new Omega seal, new expansion joints in roads, wedge shape transitions in asphalt and some temporary transitions to cover the short period until the new joints are installed.



# 10 Costs

## 10.1 Introduction

Based on the recommendations from the Structural Expert Group, presented in Section 8 and 9 of this report, combined with the budgets identified in the current 10-year budget for the Limfjord Tunnel, a 50 years budget has been developed.

The costs have been grouped under the following four headings:

- A) Basic Operation & Maintenance  
(Covers basic activities necessary to keep the tunnel in operation.)
- B) Supplementary Inspection, Monitoring and Maintenance  
(Supplementary activities recommended by the Structural Expert Group together with special activities identified in existing 10 years budget.)
- C) Major repairs/replacement  
(Major repairs and replacement activities recommended by the Structural Expert Group together with special activities identified in existing 10 years budget.)
- D) Expert Group proposals – Retrofitting  
(Preferred retrofitting projects proposed by the Structural Expert Group.)

The tasks included under each of the four headings are shown in [Table 10.1-1](#).

Group
Task
<b>A) Basic Operation &amp; Maintenance</b>
Consultant, General O&M - Average
Consultant, Inspections - Average
Maintenance contractor O&M - Average
Repairs - Average
Power, water, fees, safety drills etc.
Crack injection + fire proofing repair
<b>B) Supplementary Inspection, Monitoring and Maintenance</b>
Follow-up inspections every 3 years
Permanent monitoring, Installation and follow up
Cathodic protection, follow up
Inspections and analyses before Expert Group proposals

Group
Task
Flooding - Analysis
Ship impact - Analysis
Monitoring of settlements (Fibre optic cable)
Maintenance and repair, structures
<b>C) Major repairs/replacements</b>
Cathodic protection, installation
Replacement of fire protection
Concrete repairs, inside
Replacement of Omega joint, south
Replace surfacing
Repair bearings and joints
Replace lighting
Replace M&E (ITS, UPS, PLC all inclusive)
Ventilation, renewal
<b>D) Expert Group proposals – Retrofitting</b>
Additional prestressing (year 2035)
Replace bearing blocks (year 2045)
Active horizontal compensation grouting (year 2064)

**Table 10.1-1 Grouping of tasks included in the budget.**

## 10.2 Retrofitting Budgets

The budgets for the three retrofitting options are given in [Table 10.2-1](#).

Retrofitting option	Reference	Budget [mDKK]
Structural, Additional prestressing	[10]	35 – 40
Structural, Bearing blocks	[10]	35 – 40
Geotechnical, Compensation grouting	[7]	200 – 240

**Table 10.2-1 Retrofitting Budgets.**

The budgets from [Table 10.2-1](#) have been established through the following process:

- Best estimate price for the technical part of the different retrofitting options has been given in the different retrofitting reports (references appear in [Table 10.2-1](#)).
- A risk-workshop has been conducted by DRD with the results being presented in a Risk Analysis Report, reference [20]. Owners costs to project development, supervision and administration, termed PTA-costs, have been included in reference [21] together with a risk assessment for each of the retrofitting options.
- The output from the Risk Analysis Report is one price for each retrofitting option while [Table 10.2-1](#) provides a cost range for each option. The budget-interval from [Table 10.2-1](#) is the preferred approach given the uncertainty at this stage of the design process.

The budget for the retrofitting options in [Table 10.2-1](#) is included in the 50-year plan (Section 10.3) by the mean value of the budget-range provided in [Table 10.2-1](#), e.g. the compensation grouting is represented by 220 million Danish kroner.

## 10.3 50 years budget

The 50 years budget is shown in [Figure 10.3-1](#).

As can be seen budgets for activities for groups A) and B) have been summarized under the heading "Basic activities" as this includes all standard activities concerning operation, maintenance and retrofitting to be carried out within the normal yearly budgets.

Budgets for extraordinary activities proposed in group C) and D) are shown individually.

The budget numbers are summarized in [Table 10.3-1](#).

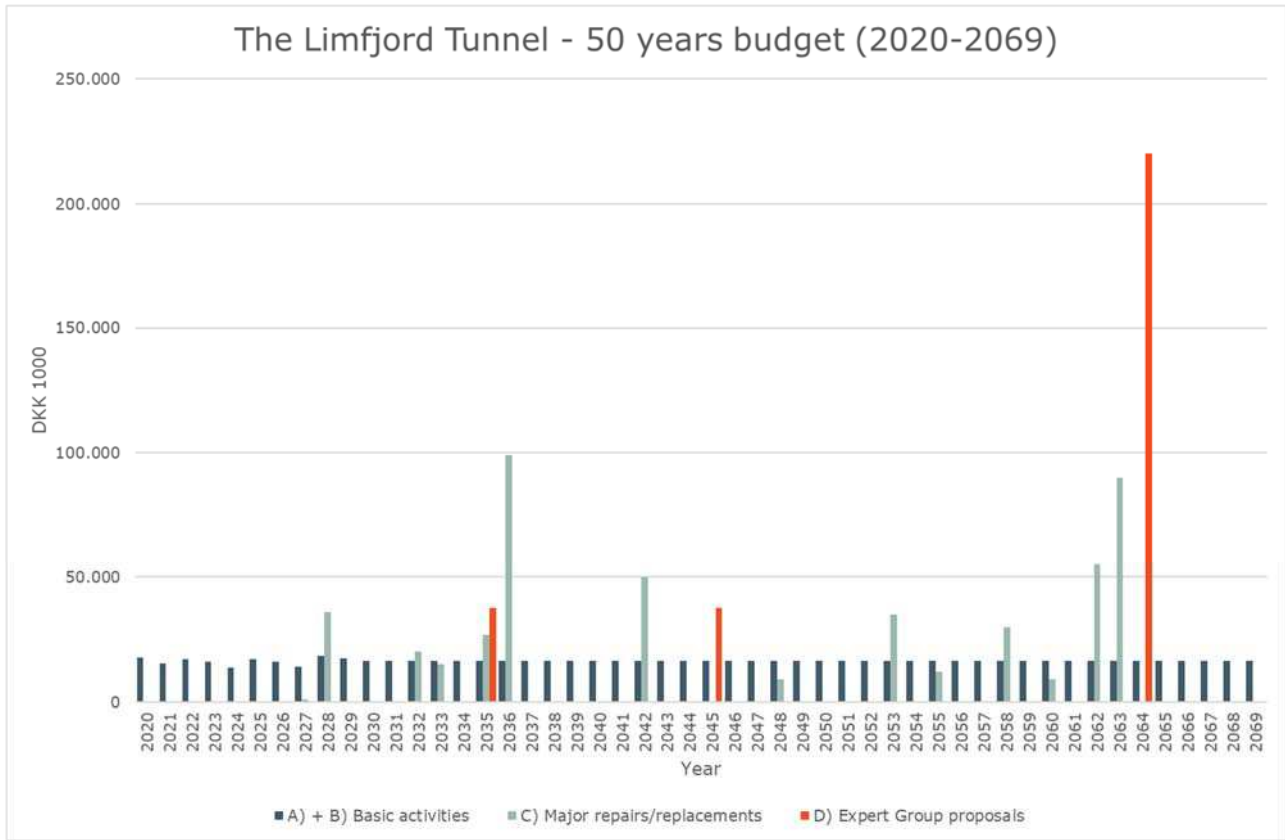

Figure 10.3-1 50 years budget for the Limfjord Tunnel based on current 10 years budget supplemented with activities recommended by the Structural Expert Group.

Group	Average 2020-2029 [1000 DKK/year]	Average 2030-2069 [1000 DKK/year]	Sum 2020-2069 [1000 DKK]
A)	11.445	11.445	572.250
B)	4.905	5.105	253.250
A)+B)	16.350	16.550	825.500
C)	3.680	11.275	487.800
A)+B)+C)	20.030	35.200	1.313.300
D)	0	7.375	295.000
A)+B)+C)+D)	20.030	42.575	1.608.300

Table 10.3-1 Budget summary.