



**Accident Investigation Board
Denmark**

FINAL REPORT

HCLJ510-000828

HCLJ510-2011-43

Accident to De Havilland DHC 8-106
Registration TF-JMB
Nuuk Airport (BGGH), Greenland
The 4th of March 2011

=====

FOREWORD

=====

This report reflects the opinion of the Accident Investigation Board Denmark regarding the circumstances of the accident and its causes and consequences.

In accordance with the provisions of the EU Regulation 996/2010 and pursuant to the Annex 13 of the International Civil Aviation Convention, the investigation is of an exclusively technical and operational nature, and its objective is not the assignment of blame or liability. The investigation was carried out without having necessarily used legal evidence procedures and with no other basic aim than that of preventing future accidents.

Consequently, any use of this report for purposes other than preventing future accidents may lead to erroneous or misleading interpretations.

Table of contents

SYNOPSIS	6
1. FACTUAL INFORMATION.....	7
1.1 HISTORY OF THE FLIGHT	7
1.2 INJURIES TO PERSONS	10
1.3 DAMAGE TO AIRCRAFT	10
1.4 OTHER DAMAGE	10
1.5 PERSONNEL INFORMATION.....	10
1.5.1 The commander	10
1.5.2 The first officer.....	12
1.6 AIRCRAFT INFORMATION	14
1.6.1 General	14
1.6.2 Airworthiness and maintenance	14
1.6.3 Main landing gear system.....	14
1.6.4 Crosswind limitations	16
1.7 METEOROLOGICAL INFORMATION.....	17
1.7.1 General	17
1.7.2 Wind at the BGGH area.....	17
1.7.3 SIGMET	18
1.7.4 METAR	18
1.7.5 TAF	19
1.7.6 SIGWX FL050-FL280	20
1.7.7 Wind/Temperature FL050	20
1.8 AIDS TO NAVIGATION.....	21
1.8.1 LLZ/DME RWY 23.....	21
1.8.2 Operator's instrument approach chart – runway 23	22
1.9 COMMUNICATION	23
1.9.1 General	23
1.9.2 Sondrestrom FIC.....	23
1.9.1 Nuuk AFIS.....	23
1.10 AERODROME INFORMATION.....	23
1.10.1 BGGH aerodrome.....	23
1.10.2 Terrain surrounding BGGH.....	24
1.10.3 Final approach track	25
1.11 FLIGHT RECORDERS	25
1.11.1 FDR and CVR time reference.....	25
1.11.2 Flight Data Recorder (FDR)	26
1.11.3 Cockpit Voice Recorder (CVR).....	26
1.11.4 Quick Access Recorder (QAR).....	26

1.12	WRECKAGE AND IMPACT INFORMATION.....	26
1.12.1	General	26
1.12.2	Fuse pin analysis.....	30
1.12.3	The touchdown	32
1.12.4	Vertical acceleration.....	33
1.12.5	Rate of descent.....	33
1.12.6	Lateral acceleration.....	34
1.12.7	Bank angle	34
1.12.8	Magnetic heading.....	34
1.12.9	Pitch attitude	35
1.12.10	Calibrated airspeed (CAS).....	35
1.12.11	Engine torque.....	35
1.13	MEDICAL AND PATHOLOGICAL INFORMATION	36
1.14	FIRE.....	36
1.15	SURVIVAL ASPECTS.....	36
1.15.1	Acceleration.....	36
1.15.2	Cockpit and cabin structure	36
1.15.3	Seats and seatbelts	36
1.15.4	Exposure	37
1.15.5	Injuries.....	37
1.15.6	Evacuation	37
1.16	TESTS AND RESEARCH	38
1.17	ORGANIZATIONAL AND MANAGEMENT INFORMATION	38
1.18	ADDITIONAL INFORMATION	39
1.18.1	VMC approaches to runway 23	39
1.18.2	BGGH aerodrome and procedure briefing.....	39
1.18.3	Stabilized approach policy.....	39
1.19	USEFUL OR EFFECTIVE INVESTIGATION TECHNIQUES	39
2.	ANALYSIS	39
2.1	General	39
2.2	Flight planning and enroute	39
2.3	Approach to BGGH.....	40
3.	CONCLUSIONS	41
3.1	Findings	41
3.2	Factors	41
3.3	Summary.....	42
4.	SAFETY RECOMMENDATIONS	42
4.1	Safety recommendation	42
4.2	Preventive actions.....	42

5.	APPENDICES	43
	APPENDIX 1 – APPROACH AND LANDING	44
	APPENDIX 2 – FDR PLOTS.....	60
	The approach.....	60
	The landing.....	61
	Longitudinal controls.....	62
	Lateral and directional controls	63
	Engines and propellers	63
	Navigation	65
	APPENDIX 3 – BGGH AERODROME AND PROCEDURE BRIEFING	66
	APPENDIX 4 – STABILIZED APPROACH POLICY	70

FINAL REPORT

HCLJ510-000828	Accident		
HCLJ510-2011-43			
Aircraft:	De Havilland DHC 8-106	Registration:	TF-JMB
Engines:	2 – P & W 121	Flight:	Commercial flight, IFR
Crew:	3 – no injuries	Passengers:	31 - no injuries
Place:	Runway 23 at Nuuk, Greenland (BGGH)	Date & Time:	4.3.2011 at 16:09 hrs. UTC

All time references are UTC.

Synopsis

On 4.3.2011 at 16:30 hrs, the Danish Accident Investigation Board (AIB) was notified of the accident by the Danish Transport Authority. Within the following hours, the notifications from Nuuk Airport, the Police and the Area Control Centre (ACC) Copenhagen were received.

The Canadian Transportation Safety Board (TSB), the Icelandic Aircraft Accident Investigation Board (AAIB), the European Aviation Safety Agency (EASA), the European Commission and the International Civil Aviation Organization (ICAO) were notified on 4.3.2011.

The investigation was conducted by the AIB in close cooperation with the AAIB and the TSB.

The accident flight was a commercial passenger flight from Reykjavik Airport, Iceland (BIRK) to Nuuk Airport, Greenland (BGGH).

At Kulusuk, Greenland (BGKK), the flight made a technical landing and uplifted fuel.

The flight crew got visual contact with the runway at BGGH and decided to deviate to the right (west) of the offset localizer (LLZ) to runway 23. The flight continued towards the runway from a position right of the extended runway centerline. As the aircraft approached runway 23, it was still in the final right turn over the landing threshold. The aircraft touched down on runway 23 between the runway threshold and the touchdown zone and to the left of the runway centerline. The right main landing gear (MLG) shock strut fuse pin sheared leading to a right MLG collapse. The aircraft skidded down the runway and departed the runway to the right.

Neither passengers nor crew suffered any injuries. The aircraft was substantially damaged.

The accident occurred in daylight under visual meteorological conditions (VMC).

The investigation has not resulted in any recommendations being made.

Summary

Adverse wind and turbulence conditions at BGGH led to flight crew task saturation on final approach and a breakdown of optimum cockpit resource management (CRM) resulting in a divergence from the operator's stabilized approach policy.

The divergence from the operator's stabilized approach policy caused an unstabilized approach and a hard landing leading to an excess load of the right MLG at touchdown.

According to its design, the right MLG fuse pin sheared as a result of stress.

1. Factual information

1.1 History of the flight

At 12:49/12:52 hrs, the flight made a technical landing and uplifted fuel at BGKK.

The flight was scheduled to depart BGKK at 13:05 hrs and to arrive at BGGH at 15:00 hrs.

Due to the weather conditions at BGGH, the flight crew decided to delay the departure from BGKK and await an improvement of the weather at BGGH.

The flight departed BGKK at 14:13/14:17 hrs. The commander was the pilot flying (PF) and the first officer was the pilot not flying (PNF). With reference to the filed ATS flight plan, the destination alternate aerodrome was Kangerlussuaq (BGSF).

Enroute, the flight crew got the following BGGH weather information from Sondrestrom Flight Information Centre (FIC):

14:23 hrs: Wind 150°/32 knots maximum 42 knots variable between 130° and 190°. Visibility 6 kilometers in light showers of snow with blowing and drifting snow.

15:39 hrs: Wind 160°/33 knots maximum 48 knots. Visibility 3000 meters in snow with patches of fog, low drifting snow, few clouds at 1600 feet, broken clouds at 2800 feet, temperature minus zero, dew point minus four and QNH 1015 hPa.

The FIC informed the flight crew that only one aircraft had departed BGGH and only one aircraft had landed at BGGH since the beginning of airport operation that day.

15:42 hrs: SIGMET issued for the west coast of Greenland:

The SIGMET was affecting a part of Nuuk Traffic Information Zone (TIZ). Severe turbulence was forecasted from the surface to 8000 feet. The turbulence was stationary and there was not forecasted any change.

15:44 hrs: Update on turbulence information:

It was stretching from the surface to 7000 feet and it was weakening.

During descent to BGGH, the flight crew discussed the approach, the present crosswind conditions and the consequential operational effects.

Due to the wind conditions at BGGH, the flight crew agreed on using a final flap setting of 15° instead of a flap setting of 35°. Furthermore, they agreed on flying the aircraft at an airspeed “on the high side”, flying the approach to the right of the offset localizer (LLZ) at a high altitude and at a steep approach angle and finally not aiming too close to the runway end.

When in radio contact with Nuuk AFIS, the flight crew got the following weather information:

15:57 hrs: Runway in use 23. Wind 180° (magnetic)/29 knots maximum 43 knots. QNH 1014 hPa. Temperature zero degrees. 25% of the runway covered with up to one mm compacted snow. 50% of the runway covered with loose fine snow. Braking action measured with a Tapley Decelerometer. Braking action on runway 23 55-55-50.

15:58 hrs: Runway in use 23. Wind 170° (magnetic)/24 knots maximum 43 knots. Visibility 4000 meters in light snow, moderate blowing snow. Few clouds at 1800 feet, broken clouds at 3500 feet. Temperature zero degrees. Dew point minus four. QNH 1014 hPa.

During descent passing through approximately 5000 feet, the flight crew got visual contact with the ground and shortly after (passing through approximately 4500 feet), the landing gear was selected down.

The flight crew got visual contact with the runway and a deviation to the right (west) of the offset LLZ to runway 23 was initiated (visual approach).

The flight crew observed how the wind changed the surface of the sea (ripples) and that the wind appeared to be calmer to the right of the offset LLZ. For that reason, the flight crew planned to avoid overflying areas of sea ripples.

As the aircraft came closer to the airport, the PNF pointed out areas on the surface of the sea with less ripples. It formed a “passage” to the airport (also referred to as “a worm”). The flight crew decided to follow “the worm”.

The autopilot was disengaged.

Shortly after and in a left turn at approximately 1912 feet radio altimeter (RA), flap setting 15° was selected. The calibrated airspeed (CAS) decreased from 140 knots to 110 knots. During the decrease of the CAS, the engine torque remained below 10%. At the same time, the PF called for the condition levers to maximum setting. The propeller RPM increased from approximately 1,050 to 1,200 RPM.

The flight continued towards the runway threshold from a position right of the runway centerline. The PF aimed to land the aircraft at a point between the runway threshold and the touchdown zone.

At 1485 feet RA, the “before landing checklist” was performed. The landing reference airspeed (Vref) was 102 knots and the target airspeed (Vtgt) was 117 knots.

When the aircraft was on a 3 nm final to runway 23, Nuuk AFIS reported that there was no traffic on runway 23 and the wind direction was 180° (magnetic), the wind speed was 17 knots maximum 42 knots and the wind direction was variable between 140° (magnetic) and 220° (magnetic).

The flight crew started discussing the use of flap setting and agreed on using flaps 35° as final flap setting.

The Vref was changed to 92 knots and the Vtgt was changed to 107 knots.

While the aircraft was tracking for the threshold to runway 23, it entered an area with moderate to severe turbulence.

Flap setting 35° was selected and while the aircraft was descending through approximately 711 feet RA.

In landing configuration, the aircraft approached the runway at a lateral angle of approximately 25°. The aircraft was heading towards the landing threshold runway 23.

The aircraft initiated a right turn from magnetic heading 195° towards the runway heading of 228.5° (MAG). The CAS was 115 knots decreasing and the RA was 144 feet. The rate of descent was approximately 780 feet per minute. The pitch attitude was approximately -5°.

As the aircraft approached the runway and crossed the threshold to runway 23, the bank angle was approximately 10° to the right increasing momentarily to 18°. The aircraft overshot the runway centerline to the left. The engine torque was approximately 20%.

The pitch attitude increased from -6° to -3° and prior to touchdown to +0.9°. The average rate of descent was approximately 13.5 feet per second (810 fpm).

The aircraft touched down on runway 23 between the runway threshold and the touchdown zone and to the left of the runway centerline. The aircraft touched down on the right main landing gear (MLG) with a crosswind from the left. The aircraft was banking more than 12° to the right as the aircraft touched down.

At touchdown, the vertical acceleration was approximately 3.9 G. The CAS was approximately 85 knots.

The right MLG shock strut fuse pin sheared leading to a right MLG collapse.

The aircraft skidded down the runway and departed the runway to the right.

The nose landing gear separated from the aircraft as the aircraft entered the unpaved area to the right of the runway.

The aircraft came to rest in a rocky area just outside the runway safety zone to the right of runway 23.

For a further presentation on the approach and landing – see appendix 1.

Throughout the final approach, no flight crew call outs on stabilized approach were made.

The passengers and crew evacuated the aircraft using the forward right emergency exit (service door).

1.2 Injuries to persons

Injuries	Crew	Passengers	Other
Fatal			
Serious			
Minor/None	3	31	

1.3 Damage to aircraft

The aircraft was substantially damaged.

1.4 Other damage

There were minor dents in the runway. One runway edge light was destroyed.

1.5 Personnel information

1.5.1 The commander

1.5.1.1 License and ratings

The commander was the holder of an ATPL (A) initially issued on 28.1.2003.

The license contained the following type ratings: DHC-6, F50 and DHC-8.

The type rating on DHC-8 was issued 25.1.2011.

The DHC-8 proficiency check was passed on the 25.1.2011 (Pilot in Command).

The date of last medical approval was 21.4.2010. There were no medical limitations.

1.5.1.2 Flying experience

	Last 24 hours	Last 90 days	Total
All types	2.9	44.6	8,163.6
This type	2.9	44.6	44.6
Landings this type	2	32	

1.5.1.3 Duty time

<u>The commander</u>			<u>Time between duty's (H)</u>
Check in	Check out	Duty hours	
22.2.2011 08:30	22.2.2011 20:26	11.93	38.32
24.2.2011 10:45	24.2.2011 20:30	9.75	13.50
25.2.2011 10:00	25.2.2011 22:08	12.13	13.12
26.2.2011 11:15	26.2.2011 17:08	5.88	111.37
1.3.2011 08:30	1.3.2011 14:00	5.50	18.50
2.3.2011 08:30	2.3.2011 20:06	11.60	37.40
4.3.2011 09:30	4.3.2011 22:00	12.50	

1.5.1.4 Observation Flight Log

The Observation Flight Training Log from 12.12.2010 to 23.12.2010 had 11 entries. There were two flights to and from Nuuk (BGGK), Greenland.

1.5.1.5 Line Flight Training Log

The Line Flight Training Log from 28.1.2011 to 26.2.2011 had 30 entries. There were two flights to and from Kulusuk (BGKK), Greenland. The rest of the flights were domestic within Iceland.

1.5.1.6 Line Check

The commander was released for continuous line duty on 26.2.2011. The flight was from BIRK to BGKK to BIRK.

1.5.1.7 Route and aerodrome competence qualification

Extract from the operator's Operations Manual Part A

5.2.1.6 *Route and Aerodrome Competence Qualification*

A pilot shall not be assigned as pilot-in-command unless he has obtained adequate knowledge of the route to be flown and of the aerodromes (including alternates), facilities and procedures to be used.

The period of validity of the route and aerodrome competence qualifications shall be 12 calendar months in addition to the remainder of the month of qualification or the month of the latest operation on the route or the aerodrome. Route and aerodrome competence qualification shall be revalidated by operation on the route or the aerodrome within the period of validity as prescribed above.

If revalidated within the final 3 calendar months of validity of previous route and aerodrome competence qualification, the period of validity shall extend from the date of revalidation until 12 calendar months from the expiry date of that previous route and aerodrome competence qualification.

1.5.2 The first officer

1.5.2.1 License and ratings

The first officer was the holder of an ATPL (A) initially issued on 15.4.2008.

The license contained the following type rating: DHC-8.

The type rating on DHC-8 was issued on 2.5.2010.

The DHC-8 proficiency checks were passed on 16.10.2009, 2.5.2010 and 13.10.2010 (Co-pilot).

The date of last medical approval was 13.7.2010. There were no medical limitations.

1.5.2.2 Flying experience

	Last 24 hours	Last 90 days	Total
All types	6.0	26.1	4567.1
This type	6.0	26.1	1130
Landings this type	2	8	280

1.5.2.3 Duty time

<u>The first officer</u>			<u>Time between</u>
			<u>duty's (H)</u>
Check in	Check out	Duty hours	
27.2.2011 16:00	27.2.2011 21:21	5.35	21.40
28.2.2011 18:45	1.3.2011 05:41	10.93	32.32
2.3.2011 14:00	2.3.2011 14:30	0.50	18.00
3.3.2011 08:30	3.3.2011 20:20	11.83	13.17
4.3.2011 09:30	4.3.2011 22:00	12.50	

1.5.2.4 Observation Flight Log

The Observation Flight Training Log from 2.3.2008 to 17.3.2008 had 16 entries. The flights were domestic within Iceland.

1.5.2.5 Line Flight Training Log

The Line Flight Training Log from 17.4.2008 to 5.5.2008 had 32 entries. There were three flights to and from Kulusuk (BGKK), Greenland. The rest of the flights were domestic within Iceland.

1.5.2.6 Line Check

The first officer was released for continuous line duty on 25.7.2010. The flight was from BIRK to BIEG to BIRK.

1.6 Aircraft information

1.6.1 General

Registration: TF-JMB
Type: Dash-8
Model: 106
Manufacturer: Bombardier Aerospace, Canada
Serial number: 337
Year of manufacture: 1992
Engine manufacturer: Pratt & Whitney Canada
Engines type: PW 121
Propellers: Two variable pitch

Aircraft total flight hours: 32 336:49
Aircraft total flight cycles: 35 300

ZFW:	13 865 Kg.	MZFW:	14 515 Kg. (32 000 lbs.)
TOW:	16 235 Kg.	MTOW:	16 466 Kg. (36 301 lbs.)
LW:	15 135 Kg.	MLW:	15 377 Kg. (33 900 lbs.)

Centre of Gravity (% MAC):

At TOW	34.32	FWD limit	22.40	AFT limit	37.76
At ZFW	34.16	FWD limit	18.35	AFT limit	39.61

Note: Before LMC.

The aircraft was within the mass and centre of gravity limitations.

1.6.2 Airworthiness and maintenance

The airplane maintenance records were verified to be in compliance with the established maintenance program and the airworthiness certificate was valid.

The flight logbook had no abnormal records.

1.6.3 Main landing gear system

1.6.3.1 General description

The retractable landing gear consisted of two main gear assemblies, one mounted in each nacelle under the wings, and a nose gear assembly mounted in a well in the front fuselage.

Both the main and the nose gear assemblies incorporated shock struts and dual wheels were fully enclosed by doors when retracted.

The main gear assemblies retracted rearward and the nose gear assembly retracted forward; normal extension and retraction were hydraulically actuated.

1.6.3.2 Fuse pin and Joint Aviation (JAR) requirement

To prevent the gear from rupturing the fuel tanks inside the wing box during a rough landing, a fuse pin (shear pin) was installed at each main landing gear yoke to shock strut junction. This was to comply with JAR 25.721(a) and JAR 25.963(d). The purpose of those JAR requirements was to demonstrate adequate airframe strength (especially of the wing in the fuel tank zones) up until the instant where breakage of the fuse pin occurs.

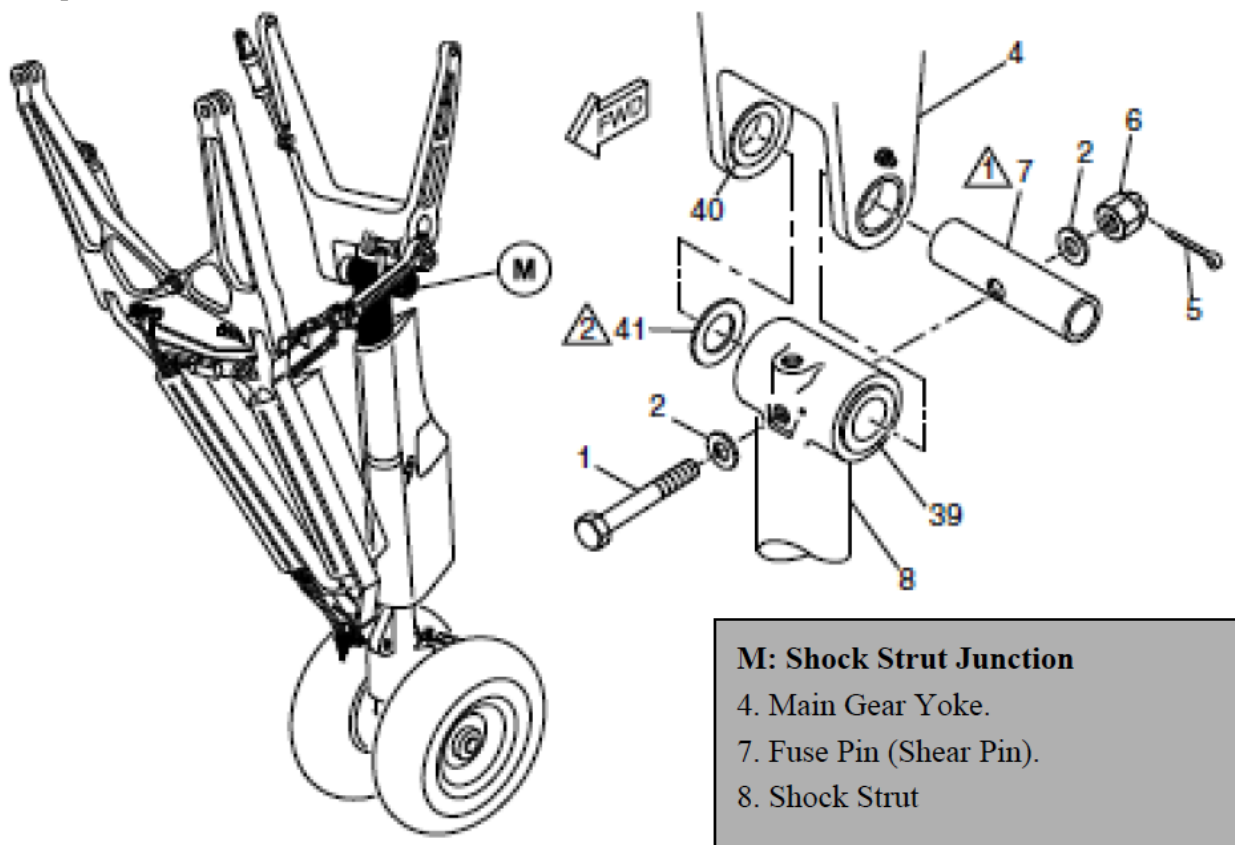

1.6.3.3 Main landing gear structural fuse pin p/n 10150-5

The structural fuse pin was designed to shear if the aircraft touched down in level attitude at a rate of decent of more than 894 to 942 feet per minute – or if - the aircraft touched down in a tail down attitude at a rate of decent of more than 996 to 1029 feet per minute.

The preconditions for those figures were landing on both MLG simultaneously at the maximum landing weight (MLW) and without any sideways movement.

In the manufacturer's maintenance program the fuse pin p/n 10150-5 had a life limit of 24 240 flights (Cycles) and did not contain periodic inspections.

At the time of the accident, the fuse pin p/n 10150-5 with serial number EXC5334 installed on the right MLG had 6 197 cycles. The remaining cycles were 18 043.

1.6.3.4 Maintenance Manual

The aircraft Maintenance Manual definition of a landing at a vertical decent rate greater than 600 feet per minute when the aircraft gross weight was less than or equal to MLW was a hard landing.

This would always require an inspection of the aircraft especially an inspection of the main landing gear system.

1.6.4 Crosswind limitations

Extract from the Airplane Operating Matters (AOM)

2.2 Crosswind Limitations

Rudder steering is highly effective and the use of asymmetric power is not necessary. In a strong crosswind tiller steering may be necessary during the early part of the take-off run, while the first officer applies into wind aileron. More than 15° of aileron control will raise the roll spoilers producing extra drag.

Mu value	Braking Action	SNOWTAM value	Max X-Wind
0.40 and above	Good	5	36
0.39-0.36	Medium/Good	4	28
0.35-0.30	Medium	3	20
0.29-0.26	Medium/Poor	2	15
0.25-0.20	Poor	1	10
Unreliable	Unreliable	Unreliable	5
Compacted snow, NO braking action reported			20
Maximum ground maneuvering wind speed is.... 60 kts			
Steep Approach: Maximum Tail-Wind Component:10 kts			

Unreliable braking action is defined as:

1. Runway covered with standing water (3 mm or more), with risk of hydroplaning or with slush.
2. Runway with high risk of hydroplaning.

1.7 Meteorological information

1.7.1 General

No telephone weather briefing related to the flight was recorded.

A deep low was situated south of Greenland and a trough was situated in the Davis Strait. A minor low (due to lack of observations not possible to estimate the centre pressure) was located just west of BGGH and was moving slowly north.

These lows were rather common and were known to produce high winds in the BGGH-area, mostly caused by the orography around BGGH where the icecap and the mountains “Lille Malene” and “Store Malene” caused wind convergence, especially near the aerodrome.

The aerodrome wind was known to be higher than the wind recorded in Nuuk city.

Weather: Light snow and drifting/blowing snow

Visibility: 2500-6000 meters in snow, tempo 0800-2000 meters in blowing snow

Clouds: Sct/bkn 1400-1600 feet and bkn 3500 feet. Cloud tops unknown

The vertical visibility in blowing snow was 0800-1200 feet

Icing: Light/moderate in clouds

QNH: 1015 hPa

1.7.2 Wind at the BGGH area

(All directions are TRUE)

The surface winds were strong and gusty. Direction 150-160 degrees, 28-35 knots with gusts to 40-43 knots.

Due to the complex terrain around BGGH and the lack of sounding (RAOB) observations, it was very difficult to estimate the wind variation with altitude.

Model-Forecasts (not WAFS but a DMI Hirlam-model) indicated a 50 knots wind at 5000 feet.

The wind variation at 5000 feet-SFC could not be estimated or described in any reliable form.

Due to the orography, the wind at 5000-3000 feet would have been more or less laminar, but with some variations in direction and airspeed during approach (wind shear).

Below 3000 feet the flow would most likely have been less laminar and more gusty and turbulent.

The wind and turbulence conditions would most likely have been significantly different south of the field.

These estimated winds below 2000 feet are highly theoretical and should be used with limited confidence:

2000 feet:	160° 40 knots gusting to 50 knots
1500 feet:	160° 35 knots gusting to 50 knots
1000 feet:	160° 35 knots gusting to 50 knots
0500 feet:	150° 30 knots gusting to 45 knots
0100 feet:	150° 30 knots gusting to 45 knots

Wind shears and turbulence below 5000 feet would have been significant (at least moderate).

1.7.3 SIGMET

At the time of the accident, there was no valid SIGMET for the Nuuk area.

A SIGMET was issued at 12:33 hrs:

BGGL SIGMET 2 VALID 041235/041515 BGSF - BGGL SONDRESTROM FIR SEV TURB FCST
ALONG SW-COAST OF GREENLAND BTN N6315 AND N6415 SFC/FL070 STNR WKN=

1.7.4 METAR

BGGH

041250 METAR bghh 041250z 16032g44kt 0800 sn blsn drsn vv010 m00/m04 q1016=

041255 SPECI bghh 041255z 16035g55kt 0800 sn blsn drsn vv010 m00/m03 q1016=

041350 METAR bghh 041350z 15036g56kt 2500 -sn blsn drsn bkn014 m00/m03 q1015=

041420 SPECI bghh 041420z 15032g42kt 120v190 6000 -shsn blsn drsn bkn015 m00/m04
q1016=

041450 METAR bghh 041450z 16033g48kt 3000 -sn bcfg drsn few016 bkn028 m00/m04
q1015=

041550 METAR bggh 041550z 16028g40kt 4000 -sn few018 bkn035 00/m05 q1015=

041650 METAR bggh 041650z 16019kt 130v190 9999 -sn few018 bkn030 01/m01 q1014 rmk
ad closed=

BGSF

041250 METAR bgsf 041250z 07004kt 9999 few080 m03/m09 q1020=

041350 METAR bgsf 041350z 08007kt 9999 few050 m03/m09 q1019=

041450 METAR bgsf 041450z 06006kt 020v090 9999 few050 m05/m10 q1019=

041550 METAR bgsf 041550z 05007kt 9999 few050 bkn200 m05/m09 q1018=

041650 METAR bgsf 041650z 06006kt 9999 sct150 bkn200 m03/m08 q1017=

1.7.5 TAF

BGGH

040900 TAF-FC bggh 040920z 0409/0418 36008kt 3000 -sn bkn015 tempo 0409/0418
07008kt 0500 sn vv004=

041000 TAF-FC bggh 041020z 0410/0419 36008kt 3000 -sn bkn015 tempo 0410/0419
07008kt 0500 sn vv004=

041000 TAF-FC COR bggh 041020z 0410/0419 36008kt 5000 -sn bkn015 tempo 0410/0417
07008kt 0500 sn vv004 tempo 0417/0419 2000 vv008=

041000 TAF-FC AMD bggh 041200z 0412/0419 10015kt 0400 +sn blsn vv004 tempo 0412/0415
17025g38kt 4000 -sn drsn bkn010 becmg 0415/0417 14012kt 9999 nsw
bkn018 tempo 0417/0419 2800 -sn vcsh bkn012=

041000 TAF-FC AMD bggh 041230z 0412/0419 15032g55kt 0400 +sn blsn vv002 tempo 0412/0415
17020kt 4000 -sn drsn bkn010 becmg 0415/0417 14012kt 9999 nsw bkn018
tempo 0417/0419 2800 -sn vcsh bkn012=

041300 TAF-FC bggh 041300z 0413/0422 15032g55kt 0400 +sn blsn vv002 tempo 0413/0416
15025g38kt 4000 -sn vv015 becmg 0416/0418 14012kt 9999 nsw bkn018
tempo 0418/0422 2800 -sn vcsh bkn012=

041300 TAF-FC AMD bghh 041425z 0414/0422 16032g48kt 1200 sn blsn vv002 tempo 0414/0416 12022g35kt 8000 -sn drsn bkn018 becmg 0416/0418 14012kt 9999 nsw bkn018 tempo 0418/0422 2800 -sn vcsh bkn012=

041600 TAF-FC bghh 041600z 0416/0501 16028g40kt 3000 -sn drsn sct015 bkn030 becmg 0417/0419 15018kt 9999 nsw tempo 0419/0501 vrb10kt 2800 -sn vcsh bkn012=

BGSF

040500 TAF-FT bgsf 040500z 0406/0506 06010kt 9999 bkn120 tempo 0406/0506 12018kt=

041100 TAF-FT bgsf 041100z 0412/0512 08012kt 9999 bkn150 tempo 0417/0423 12018kt drsn becmg 0423/0501 12018kt drsn tempo 0501/0512 16020g38kt=

1.7.6 SIGWX FL050-FL280

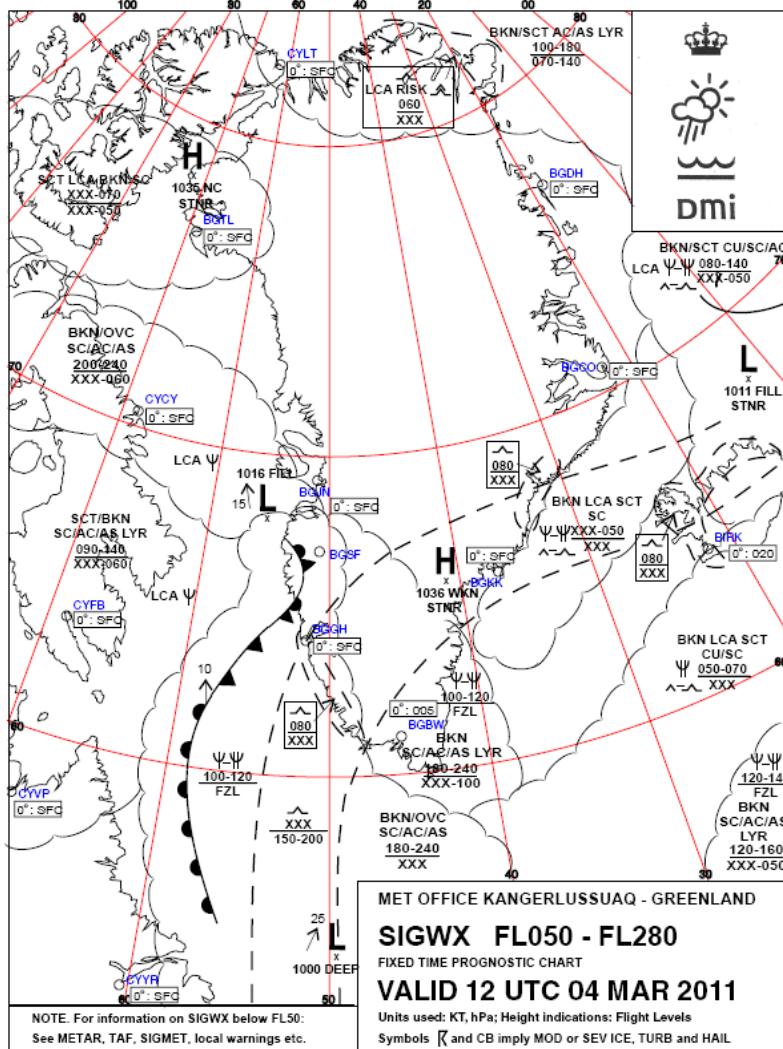

1.7.7 Wind/Temperature FL050

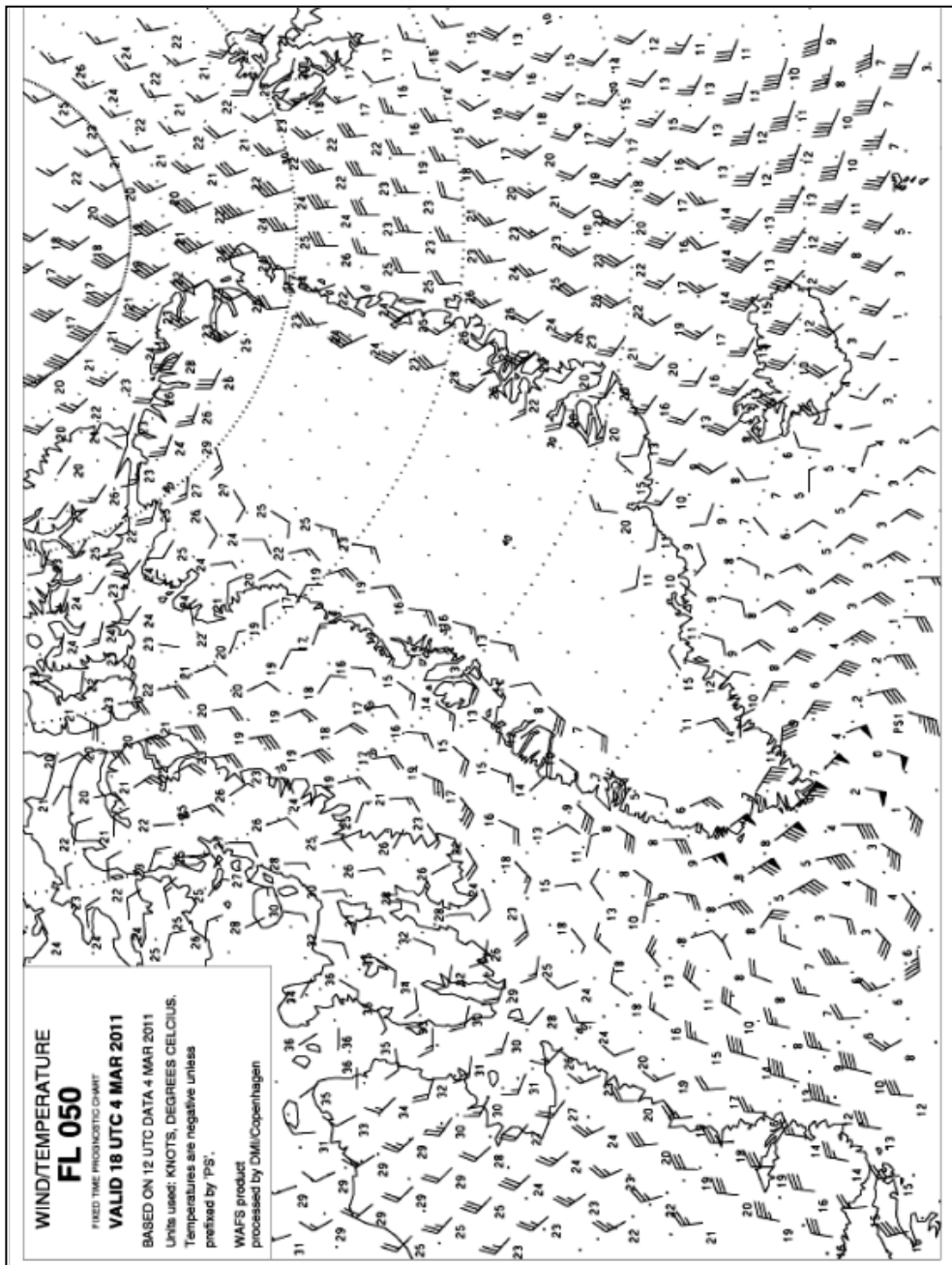

1.8 Aids to navigation

1.8.1 LLZ/DME RWY 23

The instrument approach procedure in use by the flight crew was the LLZ/DME RWY 23. The approach procedure was based on the LLZ GN 110.300 MHz and the co-located DME GN CH 40x.

At the time of the accident there were no reports concerning unserviceable approach aids to navigation at BGGH.

1.8.2 Operator's instrument approach chart – runway 23

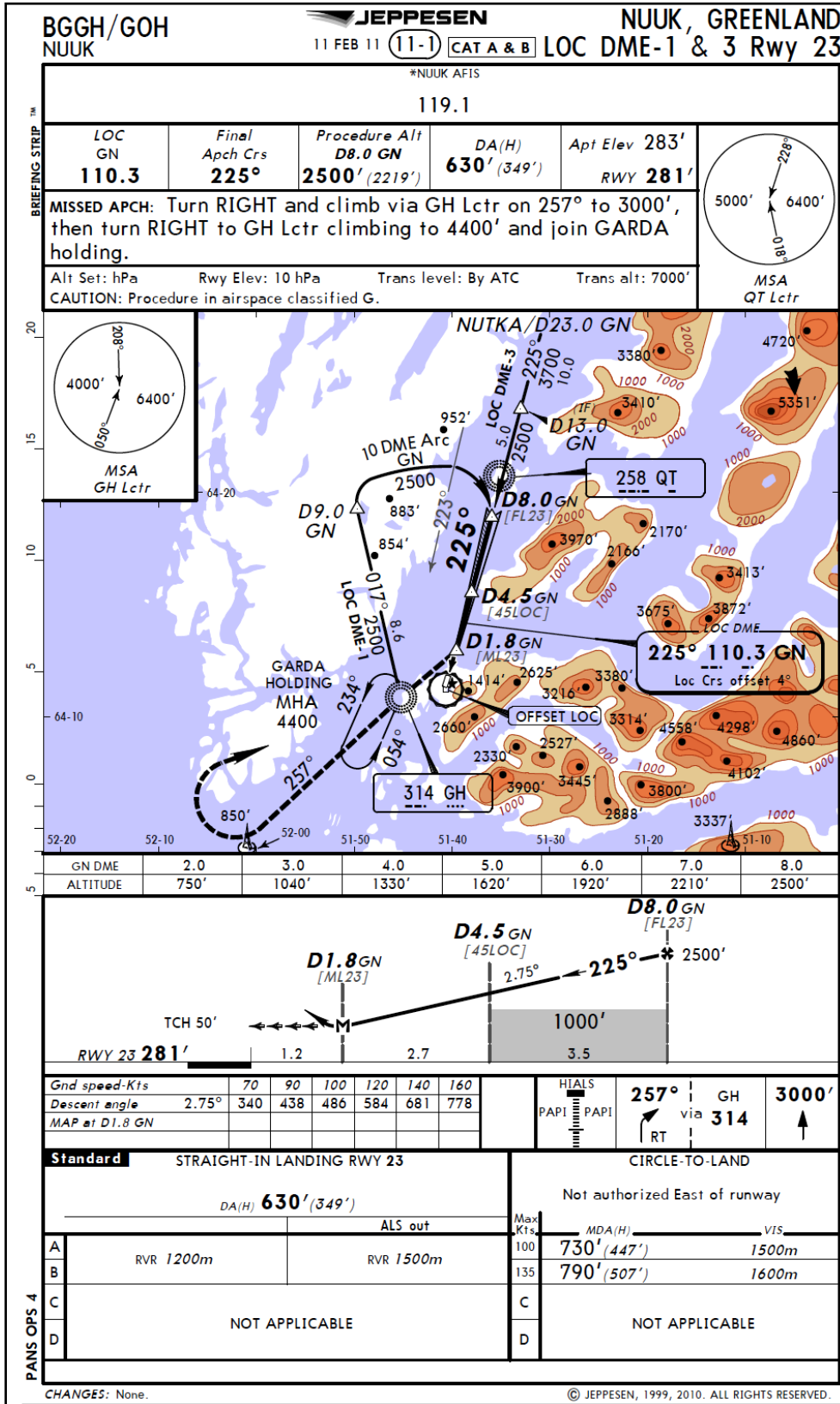

1.9 Communication

1.9.1 General

The flight crew was in VHF radio contact with Kulusuk AFIS, Sondrestrom FIC and Nuuk AFIS.

1.9.2 Sondrestrom FIC

The radio communication between the flight crew and Sondrestrom FIC (121.300 MHz) was recorded. The DK AIB obtained a copy of the recording. The recording was of good quality and was useful to the investigation.

1.9.1 Nuuk AFIS

The radio communication between the flight crew and Nuuk AFIS (119.100 MHz) was recorded. The DK AIB obtained a copy of the recording. The recording was of good quality and was useful to the investigation.

1.10 Aerodrome information

1.10.1 BGGH aerodrome

Aerodrome position (ARP):	64° 11' 27.32N 51° 40' 41.03E
Elevation:	283 feet
Magnetic variation:	30 W (January 2009)
Runway identifications:	RWY 05 and RWY 23
Direction of runway 23:	198.5° (GEO) and 228.5° (MAG)
Surface	Asphalt
Runway dimensions:	950 x 30 meters
“Strip” dimensions:	1010 x 100 meters. This area was paved (smooth). The runway was located in the center of the “strip”. Outside the “strip”, the area was rocky and unpaved
Precision Approach Path Indicator (PAPI):	A PAPI to runway 23 was located approximately at the touchdown zone. The angle was 3°.
Landing distance available – RWY 23 (LDA):	950 meters
Rescue and firefighting Service	CAT 5

1.10.2 Terrain surrounding BGGH

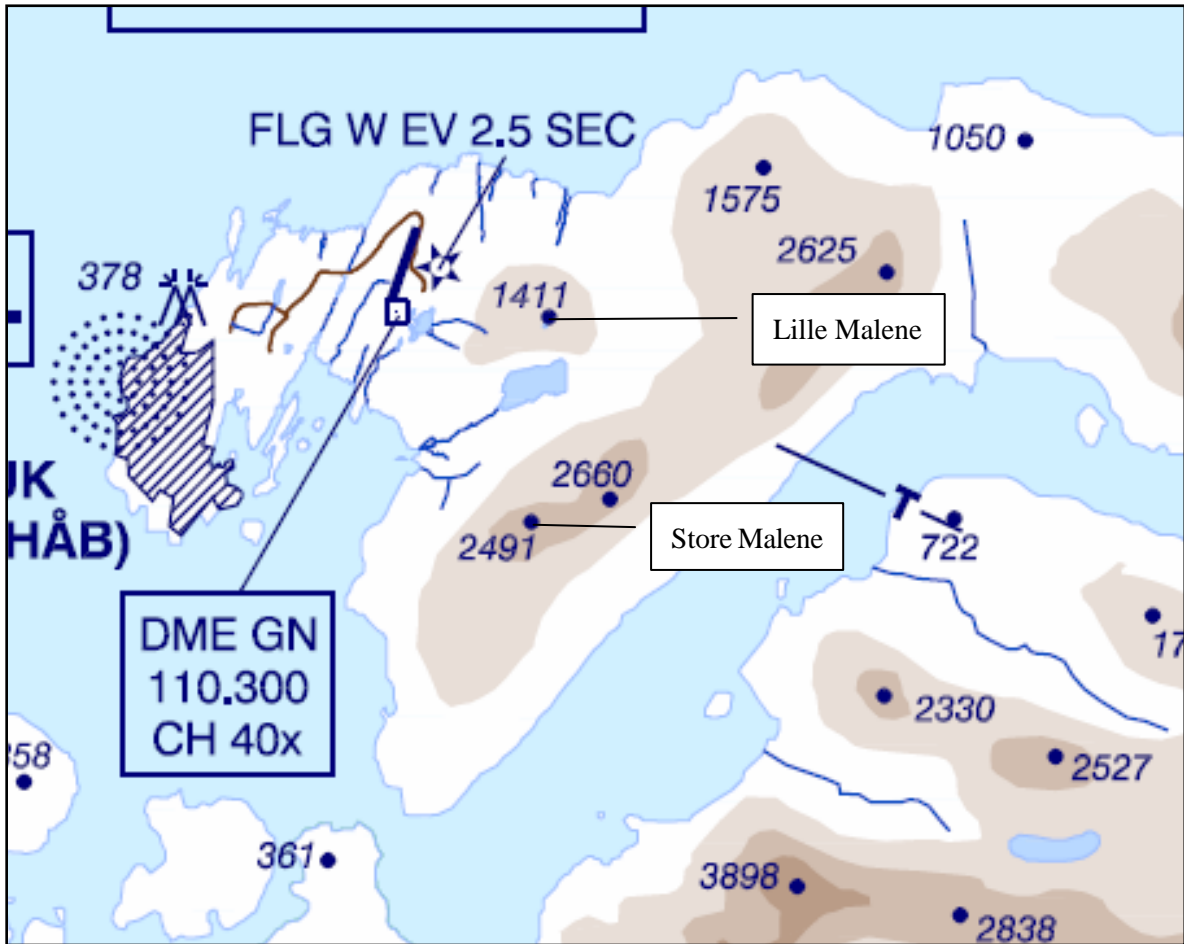

Note

The AIB has changed the scale of the AIP map and inserted the names of the mountains “Store Malene” and “Lille Malene”.

1.10.3 Final approach track

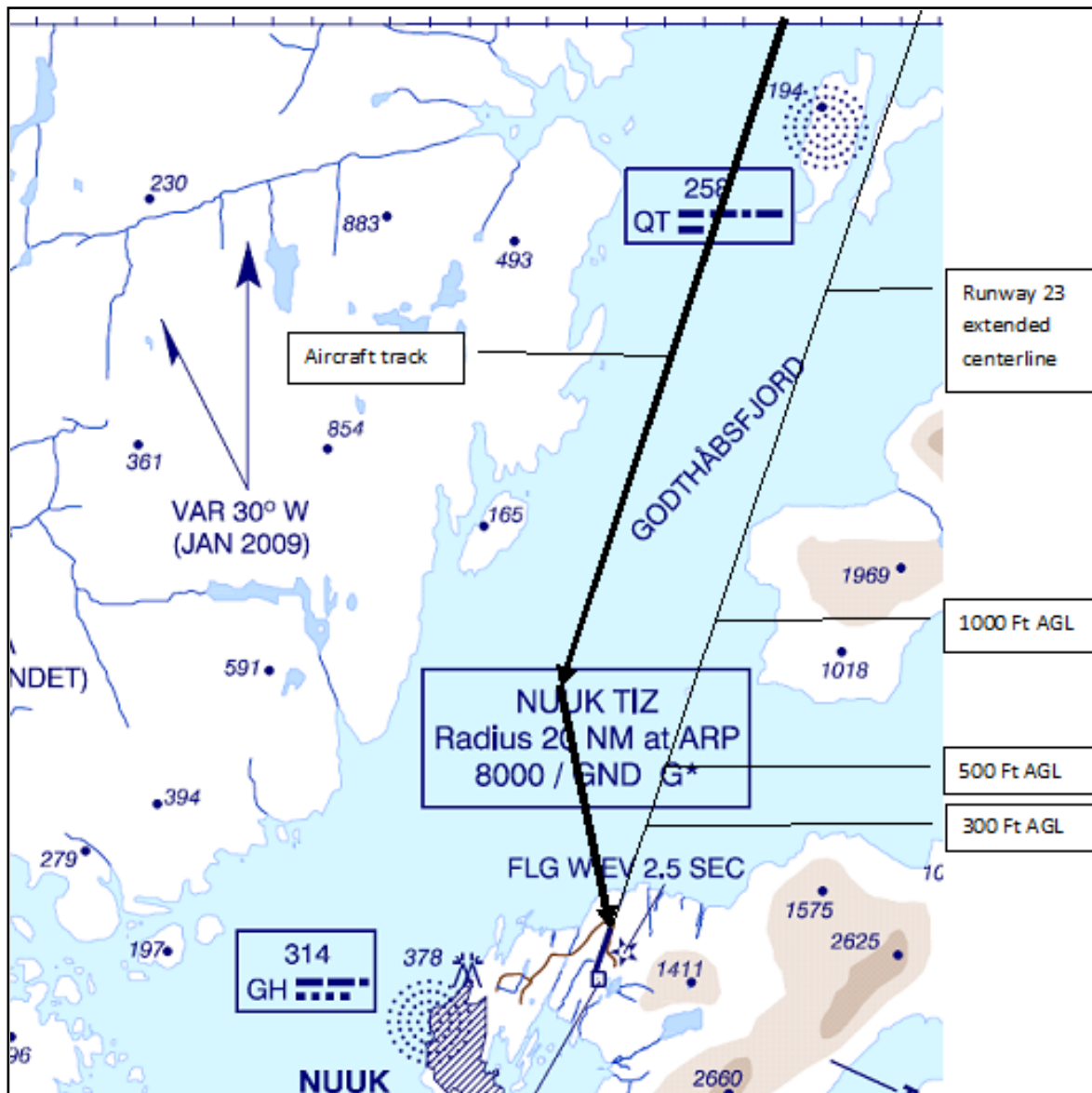

Note

The AIB has changed the scale of the AIP map and inserted the aircraft approach track. The extended centerline of runway 23 is inserted with the associated 3° approach angle heights above TDZ elevation.

1.11 Flight recorders

1.11.1 FDR and CVR time reference

The time reference used in the FDR and CVR recorded data was “relative time” and not UTC.

The time of the accident (16:09 hrs) was determined from the recorded radio communication between Nuuk AFIS and aircraft/vehicles.

The recorded “relative time” used by the FDR and CVR was transformed into UTC using the significant event recorded on the FDR and CVR.

1.11.2 Flight Data Recorder (FDR)

Shortly after the accident, the FDR was removed from the aircraft.

The recorder appeared undamaged.

The FDR was a Solid State Flight Data Recorder (SSFDR). The FDR data were retrieved and were useful to the investigation.

See appendix 2 – FDR plots.

1.11.3 Cockpit Voice Recorder (CVR)

Shortly after the accident, the CVR was removed from the aircraft.

The recorder appeared undamaged.

The CVR was a Solid State Cockpit Voice Recorder (SSCVR). The CVR data were retrieved and were useful to the investigation.

1.11.4 Quick Access Recorder (QAR)

Shortly after the accident, the QAR data chip was removed from the aircraft.

The retrieved data contained only engine parameters and were useful to the investigation.

1.12 Wreckage and impact information

1.12.1 General

At touchdown on runway 23, the right main landing gear collapsed. Immediately hereafter, the right wing hit the runway.

At first, the aircraft veered to the right and seconds later to the left. The aircraft departed the runway to the right into rocks.

The outer third of all four right propeller blades were cut off, when the blades made contact with the runway.

The right nacelle, the right wing, the flaps and aileron were damaged as a result of the runway contact.

The right main landing gear was substantially damaged due to the collapse of the gear.



As a result of hitting the rocks, the nose landing gear was destroyed and the aft fuselage suffered substantially damage.



The fuse pin of the right main landing gear was found sheared at two places.

Both ends of the fractured fuse pin were found at place in the junction.

Due to fracture of the fuse pin, the shock strut was separated from the main gear yoke.

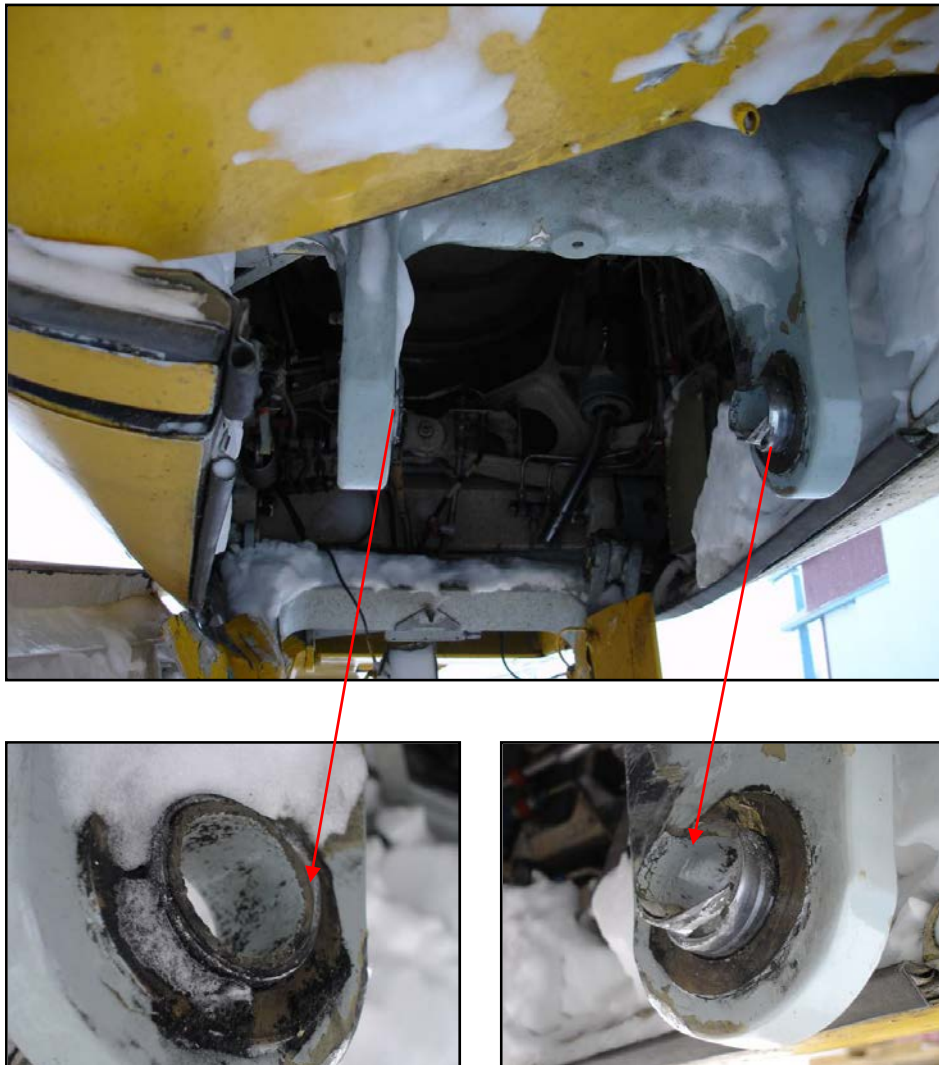

The rest of the fuse pin was found inside the head of shock strut to yoke.

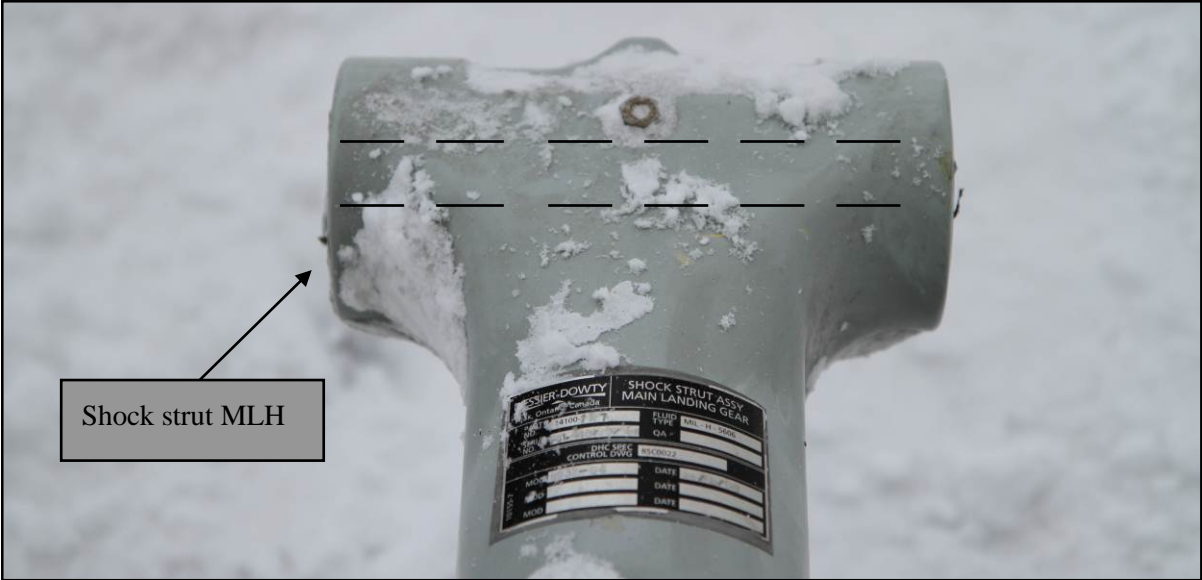

The undamaged left main landing gear – see below.



1.12.2 Fuse pin analysis

The mid-section of the fuse pin, (fig. 1 with the bolt) was found inside the head of shock strut to yoke.

The head of the bolt indicates the forward direction (flight direction). The two ends (L & R) of the fuse pin were found inside yoke junction to shock strut.

A hint of inflection on the upper side of the fuse pin can be seen, fig 1. The remaining of the fracture in the nature of a clean shear - see figure 1, 2 and 3.



Fig. 1

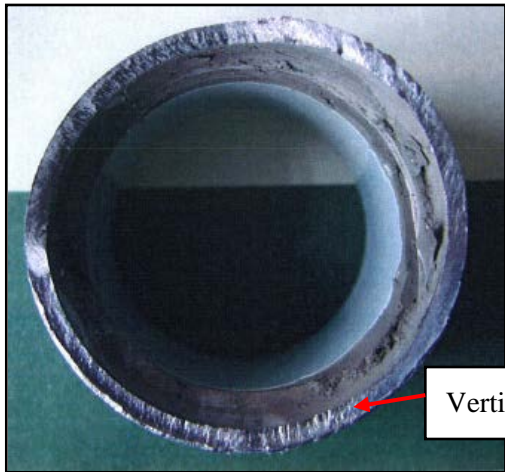

Fig. 2

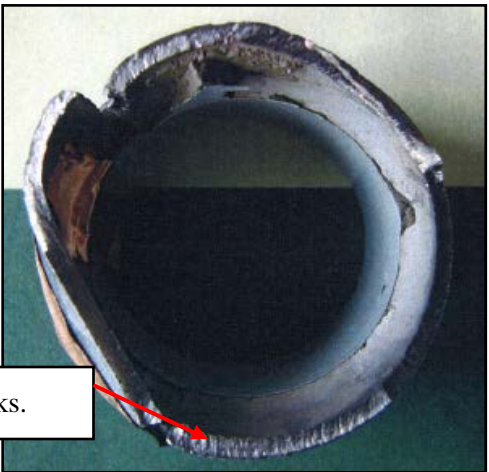

Fig. 3

Vertical upward marks.

The fuse pin was sent to the laboratory for a metal analysis. The analysis revealed the following:

The surface of the fractures from those pieces found in the gear yoke, showed marks coming from vertical upward force. This force triggered the fracture. See fig. 2 and 3.

To investigate whether there should be signs of material defects or pre-existing cracks in the fuse pin, the surfaces of fractures were examined by a Scanning Electron Microscope (SEM).

The investigation only found areas there were smeared, which did not give fractographic information and areas with dimples. Examples of areas that were found dimpled are shown in the fig. 4 (distinct shear dimples) and fig 5 (dimples characterize as overload breakage in wholesome materials).

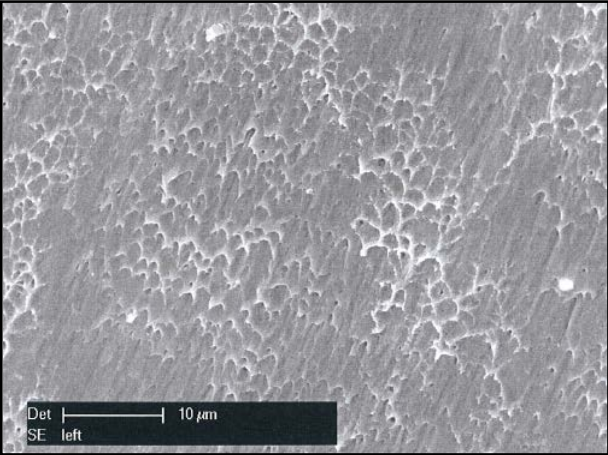

Fig. 4

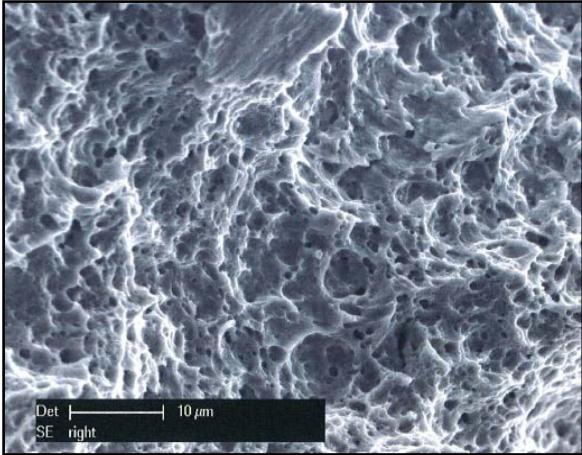

Fig. 5

Conclusions:

Fractures in the fuse pin were caused by shear (shearing).

It predominantly was a vertical-shear leading to the fractures.

There was no evidence of fault or pre-existing cracks in the fuse pin.

1.12.3 The touchdown



The aircraft touched down on runway 23 at time 16:09 hrs.

At touchdown the right MLG fuse pin sheared; consequently the right MLG collapsed and the fuselage made contact with the runway.

The wideness marks from the aft fuselage was located approximately 200 meters (600 feet) passed the landing threshold and approximately 10 meters (30 feet) to the left of the runway centerline.

1.12.4 Vertical acceleration

FDR recorded data:

<u>FDR time in UTC</u>	<u>Vertical acceleration</u>
1608:59.750	0.755 G
1608:59.875	1.181 G
1609:00.000	3.894 G

The FDR recorded the vertical acceleration eight times each second.

1.12.5 Rate of descent

FDR recorded data:

<u>FDR time in UTC</u>	<u>Radio Altimeter (RA) height</u>	<u>Radio Altimeter rate of descent</u>
1608:57.875	24.4 feet	-
1608:58.875	14.7 feet	9.7 feet/sec (582 fpm)
1608:59.875	1.2 feet	13.5 feet/sec (810 fpm)

The FDR recorded the RA once each second.

The last two recorded RA just prior to the accident were 14.7 feet and 1.2 feet above the ground.

They indicated an average rate of descent of 13.5 feet/sec (810 feet per minute). But the actual rate of descent at touchdown might have been different.

1.12.6 Lateral acceleration

FDR recorded data:

<u>FDR time in UTC</u>	<u>Lateral acceleration</u>
1608:59.500	-0.162 G
1608:59.750	-0.891 G
1609:00.000	-1.541 G

The FDR recorded the lateral acceleration four times each second. The lateral acceleration at touchdown was approximately -1.541 G.

1.12.7 Bank angle

FDR recorded data:

<u>FDR time in UTC</u>	<u>Bank angle</u>
1608:58.625	14.8° Right
1608:59.125	17.9° Right
1608:59.625	13.2° Right

The FDR recorded the bank angle twice each second. The bank angle just prior to touchdown was approximately 13.2° to the right.

1.12.8 Magnetic heading

FDR recorded data:

<u>FDR time in UTC</u>	<u>Magnetic heading</u>
1608:57.625	229.0°
1608:58.625	232.0°
1608:59.625	237.7°

The FDR recorded the magnetic heading once each second. The magnetic heading just prior to touchdown was approximately 237.7°. The direction of runway 23 was 198.5° (GEO) or 228.5° (MAG).

1.12.9 Pitch attitude

FDR recorded data:

<u>FDR time in UTC</u>	<u>Pitch attitude</u>
1608:58.875	-3.2°
1608:59.375	+0.5°
1608:59.875	+0.9°

The FDR recorded the pitch attitude twice each second. The pitch attitude just prior to touchdown was approximately +0.9° (0.9° nose up attitude).

1.12.10 Calibrated airspeed (CAS)

FDR recorded data:

<u>FDR time in UTC</u>	<u>CAS</u>
1608:57.625	110.0 knots
1608:58.625	93.5 knots
1608:59.625	85.0 knots

The FDR recorded the CAS once each second. The CAS just prior to touchdown was approximately 85 knots. The Vref was 92 knots and the Vtgt was 107 knots.

1.12.11 Engine torque

FDR recorded data:

<u>FDR time in UTC</u>	<u>Left engine torque</u>	<u>Right engine torque</u>
1608:57.500	24.2%	
1608:58.000		23.4%
1608:58.500	14.3%	
1608:59.000		8.8%
1608:59.500	11.8%	
1609:00.000		21.0%

The FDR recorded the engine torque once each second for each engine. The engine torque at touchdown was approximately 11.8% (left engine) and 21.0% (right engine).

1.13 Medical and pathological information

None

1.14 Fire

There was no fire.

1.15 Survival aspects

The accident was survivable.

1.15.1 Acceleration

FDR recorded data:

<u>Event</u>	<u>Time UTC</u>	<u>Vertical G</u>	<u>Longitudinal G</u>	<u>Lateral G</u>
Landing gear collapse	16:09:00.000	3.894	-2.000	-1.541
Nose gear collapse	16:09:12.125	1.293	-0.528	-0.022

The acceleration at time 16:09:00 occurred within one second and should not cause any injuries to persons properly seated with their seatbelts fastened.

The crew felt that the landing was a firm landing and not a hard landing and that the succeeding sliding down the runway was like a sled ride.

1.15.2 Cockpit and cabin structure

During the landing sequence, the inside of the cockpit structure and the inside of the passenger cabin structure remained almost intact.

There were no loose objects injuring the passengers or the crew.

1.15.3 Seats and seatbelts

The passengers and the crew were using seatbelts. Neither seats nor seatbelts were overstressed or suffered from malfunctioning.

1.15.4 Exposure

At the time of the accident, the remaining jet fuel onboard was approximately 1 600 L. Most of the fuel was located in the wing fuel tanks. The wings remained intact except for the outer portion of the right wing.

No significant amount of fuel (if any) left the fuel tank system during the accident.

Neither passengers nor crew was exposed to jet fuel or any other substance.

1.15.5 Injuries

Neither passengers nor crew were injured during the accident or during the evacuation [disembarkation].

1.15.6 Evacuation

After the aircraft came to a stop, the commander handled the on ground emergency from the cockpit and the first officer entered the passenger cabin to assist the cabin crew with the evacuation.

The aircraft came to rest at a bank angle of 13.7° to the right and with a nose up attitude of 2.2°.

The aircraft was equipped with one passenger door located at the left forward part of the passenger cabin, one service door located at the right forward part of the passenger cabin and two emergency exits located in the middle of the passenger cabin below each wing.

The passenger door had integrated footsteps on the inside of the door.



It became clear that there was no fire and there was no need to evacuate the aircraft in a hurry.

Outside the aircraft, the temperature was around zero degrees centigrade and the wind velocity was 20 to 40 knots. There was blowing and drifting snow.

The forward left passenger door was not suitable to use as the bank angle of the aircraft made the integrated footsteps useless since the last footstep was a half meter above the ground.

The crew decided to disembark the passengers through the forward right service door.

Before leaving the aircraft, the passengers took on their overcoats inside the cabin.

Firefighters guided the passengers across the runway to the terminal building a few hundred meters away.



1.16 Tests and research

None

1.17 Organizational and management information

The operator's headquarters was located in Iceland.

The area of operation was the North Atlantic area; primary Iceland, Faroe Islands and Greenland.

The aircraft fleet consisted of twin-engine turboprop aircraft.

The operator had an approved Operations Manual system. The system contained a description of standard operating procedures (SOP), information and limitations.

Most of the destination aerodromes were located in mountain areas where the weather environment could be a challenging task.

The majority of the airports had only non-precision approaches with a runway length of less than 2 000 meters. Destination alternate aerodromes were typically located hundreds of miles away from the destination airport.

For that reason, diversions to the destination alternate aerodromes would be a challenging task operationally and financially.

1.18 Additional information

1.18.1 VMC approaches to runway 23

ATS personnel operating at BGGH had observed similar ways of flying visual approaches as the visual approach flown by TF-JMB. This way of flying the visual approach was occasionally used when the wind direction and the wind velocity would result in moderate to severe turbulence on final to runway 23.

1.18.2 BGGH aerodrome and procedure briefing

An extract from the operator's AOM – see appendix 3

1.18.3 Stabilized approach policy

An extract from the operator's AOM – see appendix 4.

1.19 Useful or effective investigation techniques

None.

2. Analysis

2.1 General

The licenses and qualifications held by the flight crew, flight and duty times, the documented technical status of the aircraft and the aircraft mass and balance had, in the AIB's opinion, no influence on the sequence of events.

2.2 Flight planning and enroute

The flight crew planned the flight from BGKK to BGGH with the destination alternate aerodrome BGSF.

With reference to the operator's instrument approach chart (LLZ DME approach to runway 23) and the BGGH aerodrome and procedure briefing, the latest TAF (at 13:00 hrs) before departure from BGKK at

14:13/14:17 hrs, indicated marginal weather conditions (strong winds, a low visibility and a low cloud base) for a successful approach and landing at BGGH.

From a preplanning point of view, the forecasted weather conditions (0400 +sn blsn vv002) at the expected approach time at BGGH were below preplanning minima which would require preplanning with use of two destinations alternate aerodromes instead of only one.

The actual weather conditions at BGGH and enroute weather briefings were equivalent to the forecasted weather conditions.

2.3 Approach to BGGH

With reference to the operator's aerodrome and procedure briefing and the latest reported wind conditions from Nuuk AFIS before landing (wind direction 180° (magnetic), wind speed 17 knots maximum 42 knots and wind direction variable between 140° (magnetic) and 220° (magnetic)), a landing was prohibited.

Throughout the approach, a combination of strong winds and moderate to severe orographic turbulence from the surrounding mountainous terrain increased the flight crew load.

Though operating within the general crosswind limitations of the aircraft, the flight crew had difficulties of maintaining stabilized approach parameters. Furthermore, the flight crew at low altitude changed a briefed and prepared decision on the use of landing flap setting.

At altitudes below 500 feet above ground level, the extent of turbulence and flight crew work load increased. The flight crew most likely suffered from task saturation and information overload. No flight crew call outs on divergence from the operator's stabilized approach policy were made.

Important low altitude stabilized approach parameters like airspeed, bank angle and runway alignment were not sufficiently corrected. An optimum crew resource management was not present.

The AIB believes that the flight crew was solely focused on landing and that task saturation mentally blocked a decision of going around.

Just before the landing phase, the aircraft was not appropriately stabilized in order to make a safe landing.

2.4 Landing

Compensating the aircraft in the flare not being appropriately stabilized (low airspeed and banking), the flight crew did abrupt maneuvers leading to a sideways movement hard landing.

An excess load of the right MLG at touchdown caused the fuse pin to shear as a result of overload and consequently, the right MLG collapsed.

3. Conclusions

3.1 Findings

- The licenses and qualifications held by the flight crew, flight and duty times, the documented technical status of the aircraft and the aircraft mass and balance had no influence on the sequence of events
- The flight crew planned the flight from BGKK to BGGH with the destination alternate BGSF
- The latest BGGH TAF before departure from BGKK indicated marginal weather conditions (strong winds, low visibility and low cloud base) for a successful approach and landing at BGGH
- The forecasted weather conditions at the expected approach time at BGGH were below preplanning minima (use of two destination alternate aerodromes)
- The actual weather conditions at BGGH and enroute weather briefings were equivalent to the forecasted weather conditions
- With reference to the operator's aerodrome and procedure briefing and the latest reported wind conditions from Nuuk AFIS before landing, a landing was prohibited
- Strong winds and moderate to severe orographic turbulence from the surrounding mountainous terrain increased the flight crew load
- On approach, the flight crew had difficulties of maintaining stabilized approach parameters
- The flight crew most likely suffered from task saturation and information overload
- No flight crew call outs on divergence from the operator's stabilized approach policy were made
- An optimum crew resource management was not present
- Important low altitude stabilized approach parameters like airspeed, bank angle and runway alignment were not sufficiently corrected
- The flight crew was solely focused on landing and task saturation mentally blocked a decision of going around
- A divergence from the operator's stabilized approach policy caused an unstabilized approach and a hard landing leading to an excess load of the right MLG at touchdown
- The right MLG fuse pin sheared as a result of overload

3.2 Factors

- A divergence from the operator's stabilized approach policy caused an unstabilized approach and a hard landing leading to an excess load of the right MLG at touchdown
- The right MLG fuse pin sheared as a result of stress

3.3 Summary

Adverse wind and turbulence conditions at BGGH led to flight crew task saturation on final approach and a breakdown of optimum cockpit resource management (CRM) resulting in a divergence from the operator's stabilized approach policy.

The divergence from the operator's stabilized approach policy caused an unstabilized approach and a hard landing leading to an excess load of the right MLG at touchdown.

According to its design, the right MLG fuse pin sheared as a result of stress.

4. Safety recommendations

4.1 Safety recommendation

The investigation has not resulted in any recommendations being made.

4.2 Preventive actions

The operator implemented following initiatives:

Operational initiatives

- All commanders were immediately contacted by the chief pilot in order to emphasize that the SOP should be followed in BGGH as well as elsewhere
- Discussion on the stabilized approach policy
- During recurrent training, above items were emphasized
- Simulator training for all crew included a similar scenario like this accident.
- Stricter wind limits for BGGH were introduced and a graphical wind-rose was published
- During emergency training, special focus and discussions on importance of immediate action by the crew following an accident/incident.

Maintenance initiatives

The operator implemented the following as a precautionary measure for the second aircraft in operation:

- Shear pin inspection in accordance with the Bombardier AMM – rotation and freedom of movement
- Replacement of both shear pins

When the Q100 was replaced with the Q200 aircraft the following was scheduled:

- Replacement of both shear pins where scheduled at next C check

- Amended the approved AMP with further inspection to be accomplished at each C check in accordance with the Bombardier AMM
- Flight data monitoring under development to monitor G loads during landing

5. Appendices

1. Approach and landing
2. FDR plots
3. BGGH aerodrome and procedure briefing
4. Stabilized approach policy

Appendix 1 – approach and landing

Time 16:06:48 – approximately 1 912 feet RA – flaps 15° selected

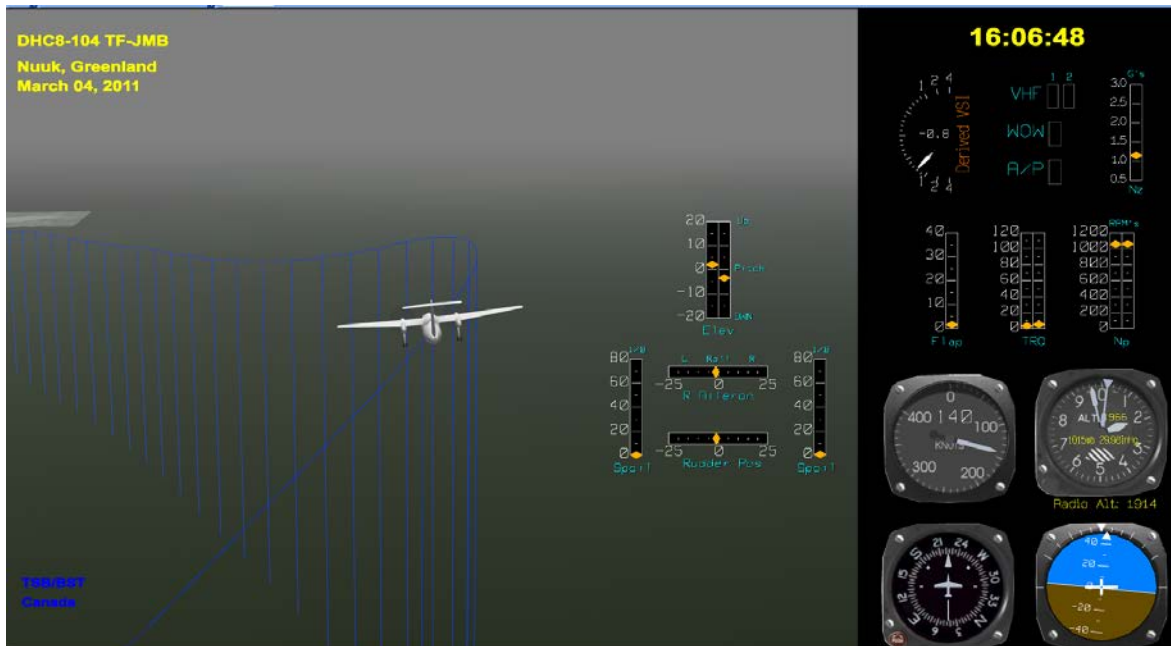

UTC	P.A. feet	CAS knots	Pitch Att	Roll Att	Eng 1 TQ %	Eng 2 TQ %	M.H. Deg	Vertical Accel (g's)	Prop 1 RPM	Prop 2 RPM	Flap (Deg)	Pitch Trim (Deg)	Radio Alt (feet)
16:06:48,375	1914		1,1					1,023					
16:06:48,500					3,5			0,982	1053,5				
16:06:48,625		140,5		-5,6			222,9	0,959					
16:06:48,750								1,016			1,7	-2,1	
16:06:48,875			0,8					0,991					1910,4
16:06:49,000						6		1,03		1056,4			
16:06:49,125				-5,6				1,06					
16:06:49,250								1,071					
16:06:49,375	1902		1,1					1,082					

The flaps were selected while the aircraft was in a left turn banking 5.6° (-5.6). The flaps were moving through 1.7° towards 15°.

The recommended airspeed with flaps up was 148 knots and the actual CAS was 140.5 knots.

The engine torque was approximately “in idle” while the flaps were moving.

Time 16:07:10 – approximately 1 517 feet RA – flaps 15° set

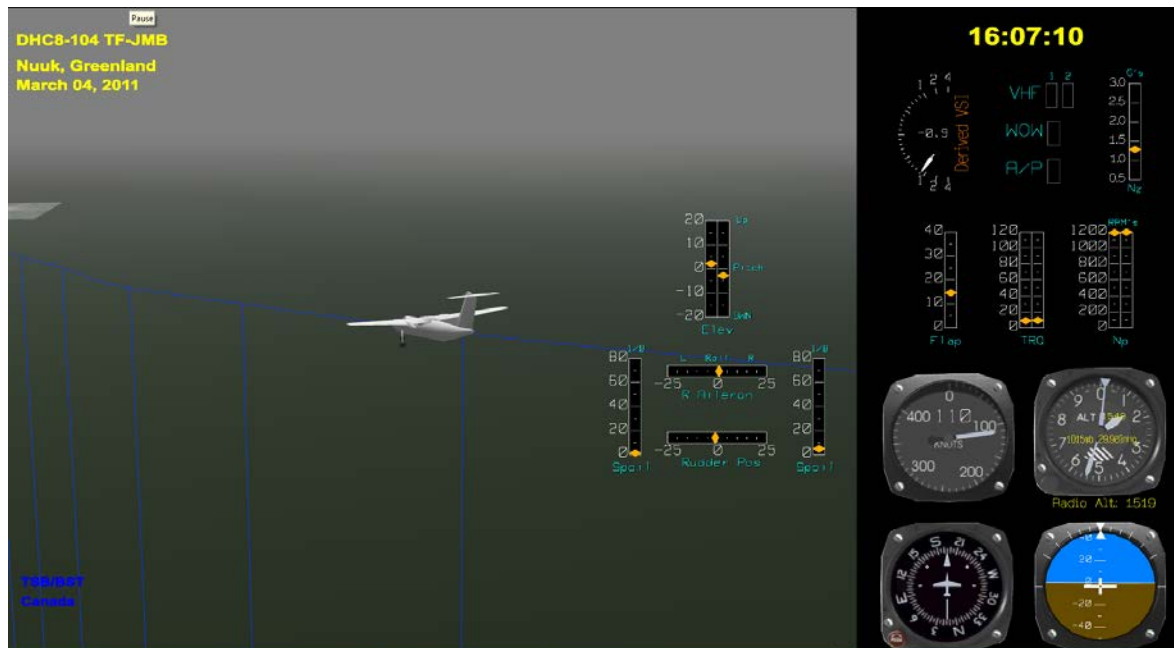

UTC	P.A. feet	CAS knots	Pitch Att	Roll Att	Eng 1 TQ %	Eng 2 TQ %	M.H. Deg	Vertical Accel (g's)	Prop 1 RPM	Prop 2 RPM	Flap (Deg)	Pitch Trim (Deg)	Radio Alt (feet)
16:07:10,375	1496		-3,3					1,048					
16:07:10,500					8,8			1,057	1187,5				
16:07:10,625		110		-0,5			194,4	1,108					
16:07:10,750								1,195			14,7	-2,1	
16:07:10,875			-2,9					1,112					1514,9
16:07:11,000						9		1,094		1192,3			
16:07:11,125				0,2				1,119					
16:07:11,250								1,048					
16:07:11,375	1482		-3,3					1,027					

The flaps were set at 15° (14.7).

The Vtgt was Vref flaps 15 (102 knots) plus correction for wind (15 knots) equal to 117 knots and the actual CAS was 110 knots.

The propeller RPM were increased from approximately 1 050 rpm to approximately 1 200 rpm.

The engine torque was approximately “in idle”.

Time 16:07:12 – approximately 1 485 feet RA – before landing checklist completed



UTC	P.A. feet	CAS knots	Pitch Att	Roll Att	Eng 1 TQ %	Eng 2 TQ %	M.H. Deg	Vertical Accel (g's)	Prop 1 RPM	Prop 2 RPM	Flap (Deg)	Pitch Trim (Deg)	Radio Alt (feet)
16:07:12,375	1468		-4					0,984					
16:07:12,500					16,6			0,984	1204				
16:07:12,625		113		0,5			194,2	0,984					
16:07:12,750								0,991			14,7	-2,1	
16:07:12,875			-4,1					1,002					1485,6
16:07:13,000						20		0,998		1204,4			
16:07:13,125				0				0,998					
16:07:13,250								1,016					
16:07:13,375	1454		-4					1,016					

The “before landing checklist” was completed.

At this time, the landing flap setting was 15°.

The Vtgt was 117 knots and the actual CAS was 113 knots.

The engine torque was increased to approximately 20%.

Time 16:07:21 – 1 408 feet RA – 3 nm out

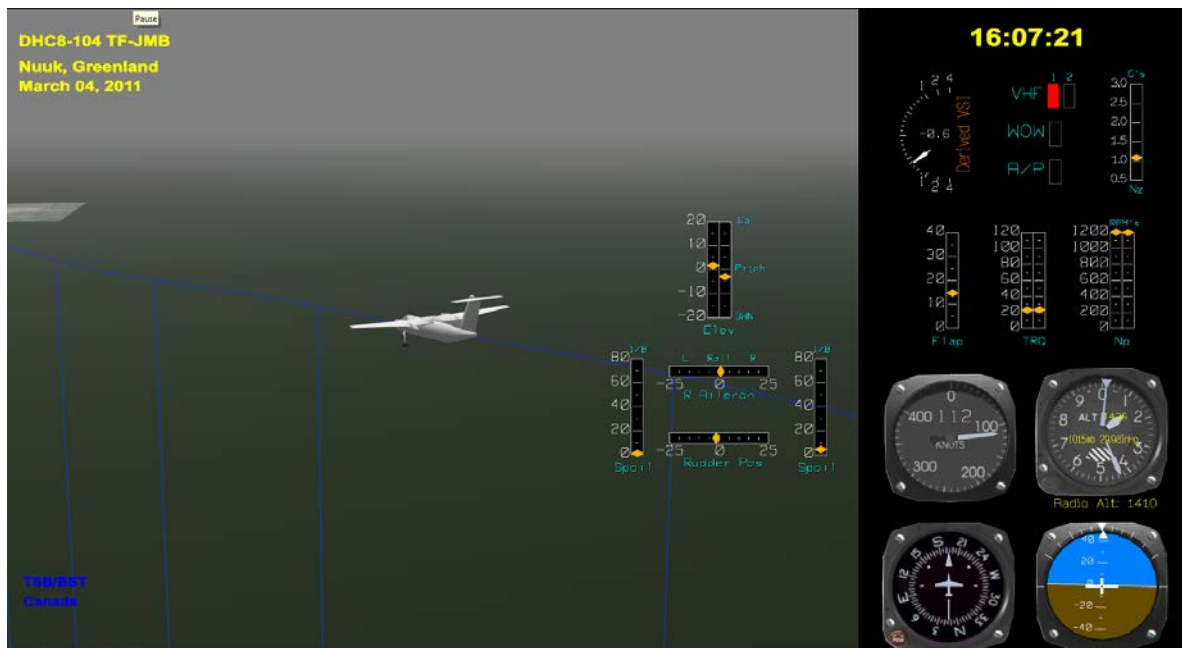

UTC	P.A. feet	CAS knots	Pitch Att	Roll Att	Eng 1 TQ %	Eng 2 TQ %	M.H. Deg	Vertical Accel (g's)	Prop 1 RPM	Prop 2 RPM	Flap (Deg)	Pitch Trim (Deg)	Radio Alt (feet)
16:07:21,375	1382		-1,1					0,979					
16:07:21,500					22,9			0,902	1203,3				
16:07:21,625		112		-1,8			193,5	0,895					
16:07:21,750								0,95				-2,1	
16:07:21,875			-0,9					0,979					1407,5
16:07:22,000						23		0,95		1195,6			
16:07:22,125				-3,7				1,009					
16:07:22,250								1,046					
16:07:22,375	1374		-0,6					1,048					

The Pitch Attitude increased from approximately -3° to -1° (nose down).

The Vtgt was 117 knots and the actual CAS was 112 knots.

The engine torque was increased to approximately 23%.

Time 16:08:18 – approximately 784 feet RA

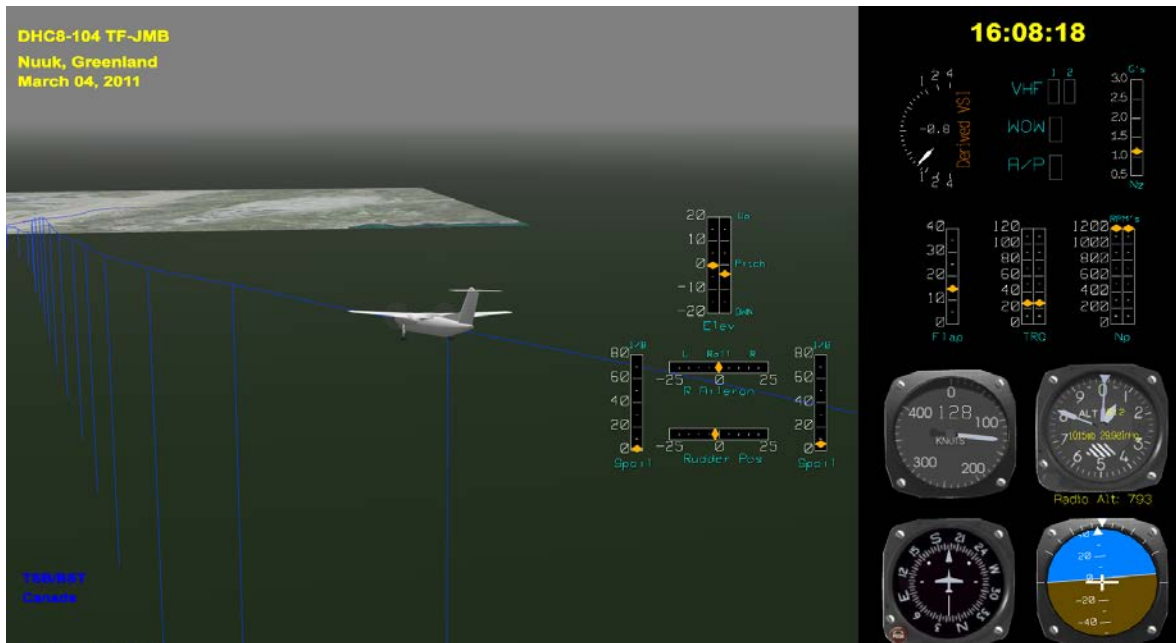

UTC	P.A. feet	CAS knots	Pitch Att	Roll Att	Eng 1 TQ %	Eng 2 TQ %	M.H. Deg	Vertical Accel (g's)	Prop 1 RPM	Prop 2 RPM	Flap (Deg)	Pitch Trim (Deg)	Radio Alt (feet)
16:08:18,875			-2,9					1,13					787,4
16:08:19,000					26			1,204		1193,8			
16:08:19,125				5,4				1,247					
16:08:19,250								1,275					
16:08:19,375	732		-2,1					1,199					
16:08:19,500					25,7			1,206	1197,8				
16:08:19,625		122		2,5			197,6	1,268					
16:08:19,750								1,211				-1,2	
16:08:19,875			-3,1					0,991					776,4

The aircraft continued on a track at an offset angle towards the landing threshold runway 23 at an angle of 25° to 35°.

The Pitch Attitude was approximately -3° to -2° (nose down).

The Vtgt was 117 knots and the actual CAS was 122 knots.

The engine torque was increased to approximately 26%.

Time 16:08:24 – approximately 711 feet RA - flaps 35° selected

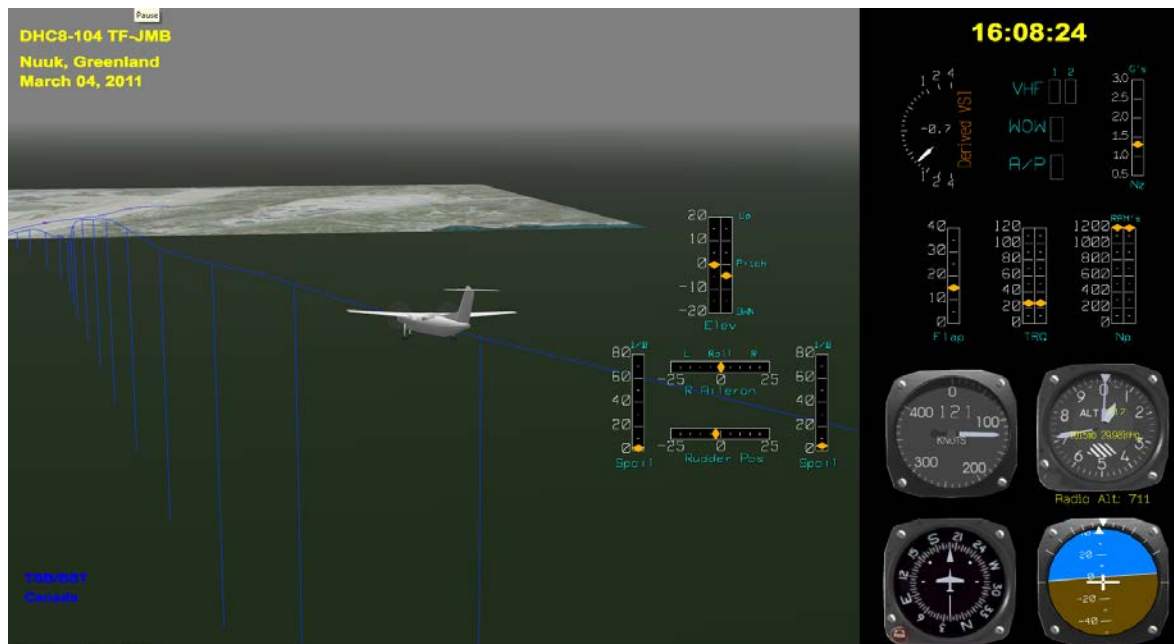

UTC	P.A. feet	CAS knots	Pitch Att	Roll Att	Eng 1 TQ %	Eng 2 TQ %	M.H. Deg	Vertical Accel (g's)	Prop 1 RPM	Prop 2 RPM	Flap (Deg)	Pitch Trim (Deg)	Radio Alt (feet)
16:08:24,375	650		-4					1,078					
16:08:24,500					25,9			0,961	1205,9				
16:08:24,625		121,5		4			200,4	1,002					
16:08:24,750								1,185			15,1	-1,2	
16:08:24,875			-5					1,13					709,2
16:08:25,000						26		0,881		1201,1			
16:08:25,125				5,8				0,679					
16:08:25,250								0,538					
16:08:25,375	682		-5,7					0,615					

The flaps were moving from flap setting 15° towards flap setting 35°.

The aircraft continued on a track at an offset angle towards the landing threshold runway 23 at an angle of 25° to 35°. The Pitch Attitude decreased to approximately -4° to -6° (nose down).

The Vtgt was 117 knots and the actual CAS was 121.5 knots.

The engine torque was steady at approximately 26%.

Time 16:08:34 – approximately 626 feet RA – flaps 35° set

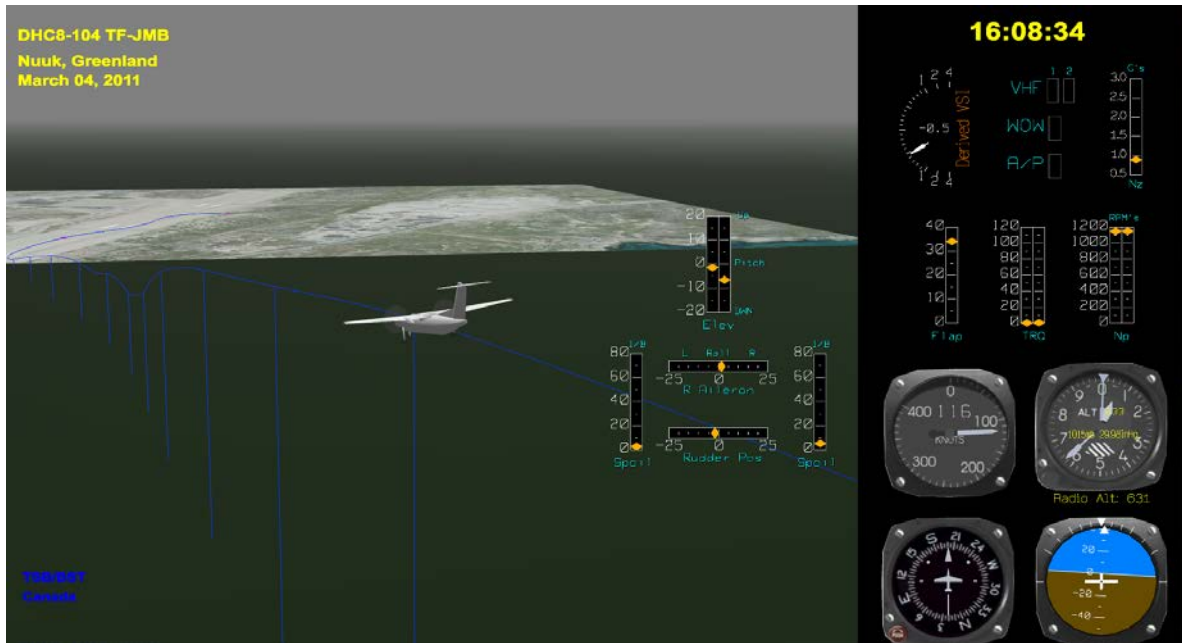

UTC	P.A. feet	CAS knots	Pitch Att	Roll Att	Eng 1 TQ %	Eng 2 TQ %	M.H. Deg	Vertical Accel (g's)	Prop 1 RPM	Prop 2 RPM	Flap (Deg)	Pitch Trim (Deg)	Radio Alt (feet)
16:08:34,375	578		-7,3					0,744					
16:08:34,500					0			0,734	1139,9				
16:08:34,625		115,5		-4			200,9	0,737					
16:08:34,750								0,792			34,1	-0,2	
16:08:34,875			-6,6					0,872					625
16:08:35,000						1		0,906		1139,2			
16:08:35,125				-0,7				0,952					
16:08:35,250								0,924					
16:08:35,375	548		-5,5					0,874					

The flaps were set at flap setting 35°.

The aircraft continued on a track towards the landing threshold runway 23 at an angle of 25° to 35°.

During the flaps extension from flap setting 15° to flap setting 35°, the engine torque decreased from approximately 26% to 0% (idle power). The pitch attitude decreased to approximately -5° to -7° (nose down).

Time 16:08:40 – approximately 530 feet RA – airspeed 17 knots below Vtgt

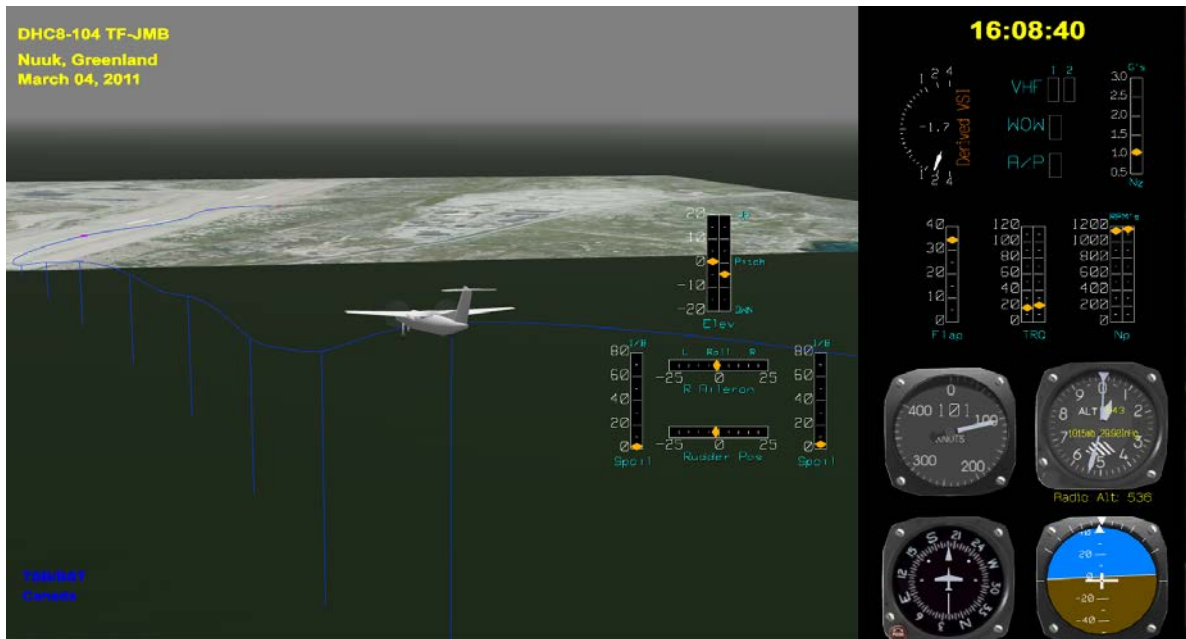

UTC	P.A. feet	CAS knots	Pitch Att	Roll Att	Eng 1 TQ %	Eng 2 TQ %	M.H. Deg	Vertical Accel (g's)	Prop 1 RPM	Prop 2 RPM	Flap (Deg)	Pitch Trim (Deg)	Radio Alt (feet)
16:08:40,625		101		2,5			200,7	0,856					
16:08:40,750								0,947			34,2	-0,2	
16:08:40,875			-2,5					0,973					529,8
16:08:41,000						29		1,002		1150,2			
16:08:41,125				2,6				1,126					
16:08:41,250								1,076					
16:08:41,375	458		-1,8					1,018					
16:08:41,500					40,3			1,092	1125,6				
16:08:41,625		90		4,6			201,1	1,119					
16:08:41,750							1					-0,2	
16:08:41,875			-1,6					1,016					468,8

The aircraft continued on a track towards the landing threshold runway 23 at an angle of 25° to 35°.

As the airspeed momentarily decreased to 90 knots, the engine torque increased from slightly above idle to 30% - 40%.

The Vtgt was 107 knots, and the actual CAS momentarily decreased to 90 knots.

Time 16:08:57 – 30 feet above the runway – banking 18° to the right

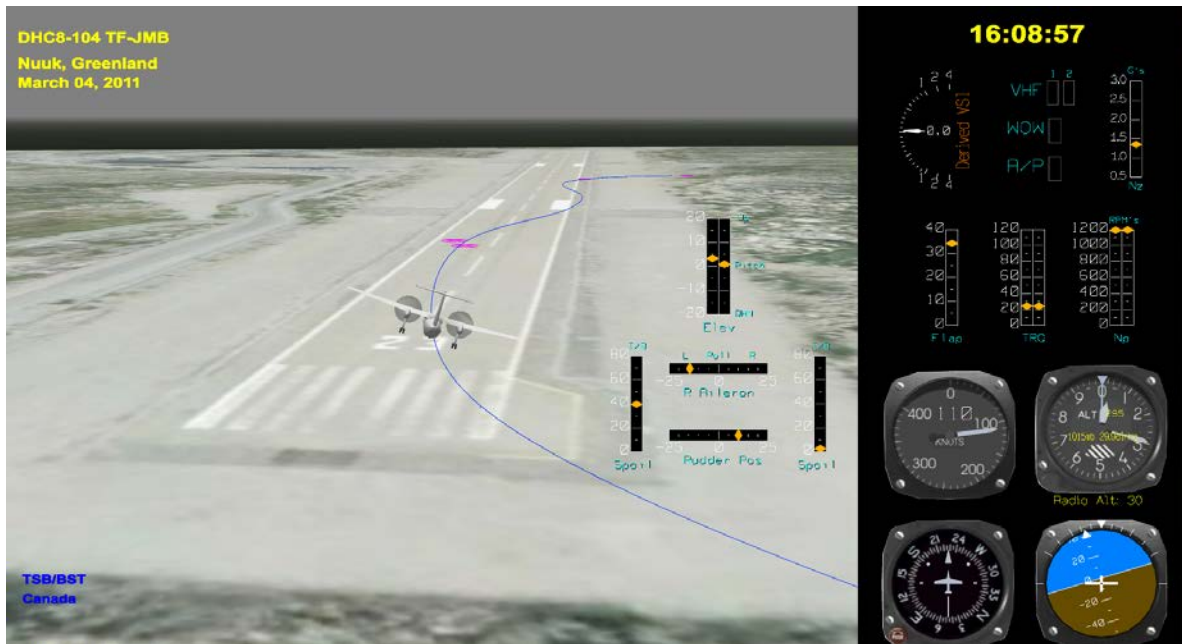

UTC	P.A. feet	CAS knots	Pitch Att	Roll Att	Eng 1 TQ %	Eng 2 TQ %	M.H. Deg	Vertical Accel (g's)	Prop 1 RPM	Prop 2 RPM	Flap (Deg)	Pitch Trim (Deg)	Radio Alt (feet)
16:08:56,875			-4,8					1,208					37,8
16:08:57,000					24			1,147		1193			
16:08:57,125				16				1,256					
16:08:57,250								1,256					
16:08:57,375	240		-4,6					1,149					
16:08:57,500					24,2			1,224	1186,8				
16:08:57,625		110		18,3			229	1,11					
16:08:57,750								1,053				-0,3	
16:08:57,875			-5,8					1,027					24,4

The aircraft had passed the runway threshold and descended through 30 feet above runway 23.

The aircraft was banking up to 18.3° to the right but it was drifting to the left. The aircraft overshot the runway centerline to the left. The engine torque was around 24% and was about to be reduced. The RA decreased from 37.8 feet to 24.4 feet or 13.4 feet in one second (804 fpm).

The pitch attitude decreased from the previous -3° to -4° (nose down) to -5.8° (nose down).



The picture was taken near the road to the left of runway 23 while the aircraft approached the landing threshold.

Time 16:08:59 – the flare

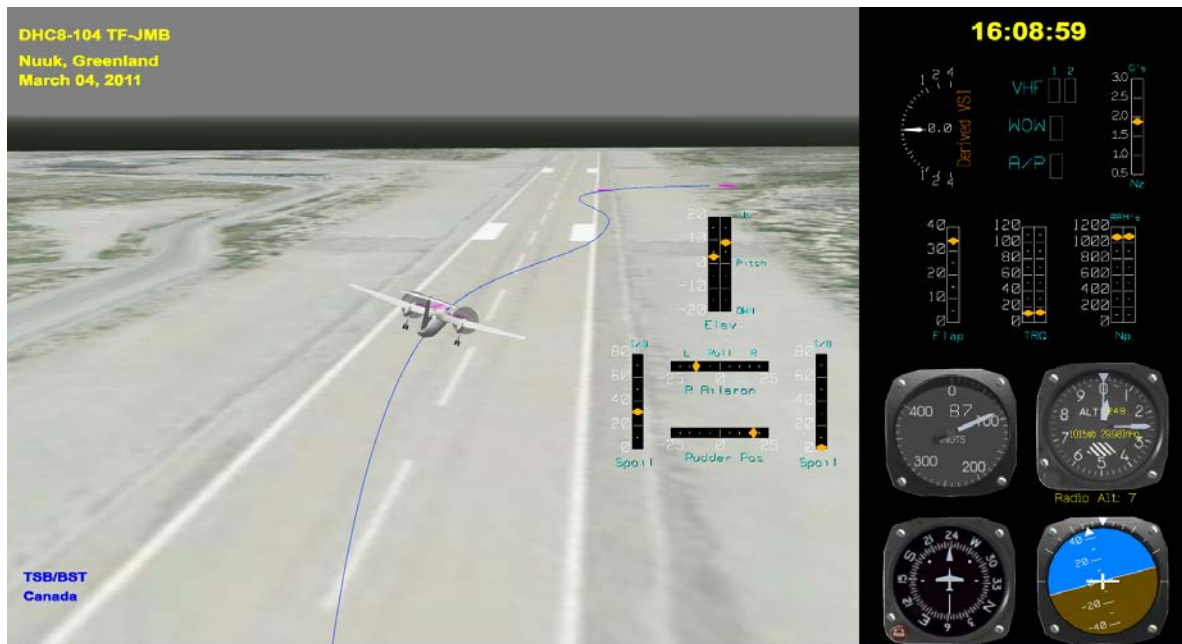

UTC	P.A. feet	CAS knots	Pitch Att	Roll Att	Eng 1 TQ %	Eng 2 TQ %	M.H. Deg	Vertical Accel (g's)	Prop 1 RPM	Prop 2 RPM	Flap (Deg)	Pitch Trim (Deg)	Radio Alt (feet)
16:08:58,875			-3,2					1,021					14,7
16:08:59,000					9			0,993		1142,1			
16:08:59,125				17,9				0,931					
16:08:59,250								0,863					
16:08:59,375	194		0,5					1,762					
16:08:59,500					11,8			1,394	1055,3				
16:08:59,625		85		13,2			237,7	0,533					
16:08:59,750								0,755				-0,2	
16:08:59,875			0,9					1,181					1,2

The aircraft was in the landing flare. The aircraft was still banking up to 17.9° to the right and the drift to the left had stopped. The aircraft was left of the runway centerline.

The engine torque was reduced to around 10%. The RA had dropped from 14.7 feet to 1.2 feet or 13.5 feet in one second (810 fpm). The pitch attitude was increased from the previous -5.8° (nose down) to +0.9° (nose up) in two seconds.

The target airspeed was 107 knots (Vref+15). The CAS was 85 knots.

The aircraft magnetic heading (MH) was 237.7° while the runway magnetic heading was 228.5°.

Time 16:09:00 – touchdown



UTC	P.A. feet	CAS knots	Pitch Att	Roll Att	Eng 1 TQ %	Eng 2 TQ %	M.H. Deg	Vertical Accel (g's)	Prop 1 RPM	Prop 2 RPM	Flap (Deg)	Pitch Trim (Deg)	Radio Alt (feet)
16:08:59,500					11,8			1,394	1055,3				
16:08:59,625	85		13,2				237,7	0,533					
16:08:59,750								0,755				-0,2	
16:08:59,875			0,9					1,181					1,2
16:09:00,000					21			3,894		953,1			
16:09:00,125				11,4				0,908					
16:09:00,250								0,929					
16:09:00,375	188		1,4					0,588					

The RA had dropped from 14.7 feet to 1.2 feet in one second. The average rate of descent from RA 14.7 feet to RA 1.2 feet was 13.5 fps (810 fpm).

The aircraft touched down on runway 23 approximately 10 meters (30 feet) left of the runway centerline and approximately 200 meters (600 feet) from the runway landing threshold.

Just prior to touchdown the aircraft was banking 13.2° to the right with a pitch attitude of +0.9° (nose up). As a consequence, the touchdown was on the right MLG only. The magnetic heading at touchdown was approximately 237.7°.

The right MLG fuse pin sheared and consequently, the right MLG collapsed.

Time 16:09:02 – aircraft sliding down the runway

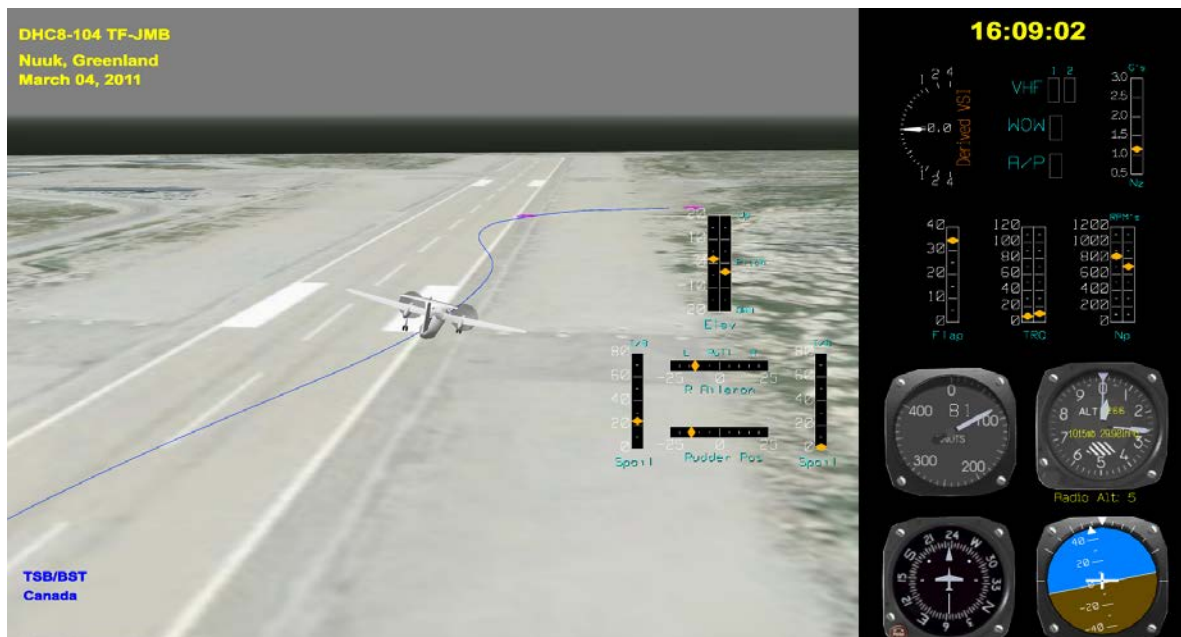

UTC	CAS	MH	Vertical Accel (g's)	Prop Beta Eng#1	Prop Beta Eng#2	Prop 1 RPM (rpm)	Prop 2 RPM (rpm)	Eng 1 Torque (%)	Eng 2 Torque (%)	Eng 1 NH (%rpm)	Eng 2 NH (%rpm)	Roll Attitude	Rudder Positon
16:09:02,000			1,085				611,7		13,3				
16:09:02,125			1,027							77,3		12,1	
16:09:02,250			0,993										
16:09:02,375			1,073	Not Beta	Not Beta								-14,3
16:09:02,500			1,071			820,5		7,9					
16:09:02,625	82,5	237,3	1,055								76,9	12	
16:09:02,750			0,92										
16:09:02,875			1,011										-14
16:09:03,000			1,076				748,7		10				
16:09:03,125			0,961							73,5		12,5	

The aircraft was sliding down runway 23.

The directional control of the aircraft was achieved by the use of the rudder.

The CAS was 82.5 knots making the rudder effective.

Both the engine turbines were running. The propeller on engine #1 was producing forward power (7.9% torque)] and was not used to maintain directional control.

Time 16:09:08 – aircraft sliding off the runway



UTC	CAS	MH	Vertical Accel (g's)	Prop Beta Eng#1	Prop Beta Eng#2	Prop 1 RPM (rpm)	Prop 2 RPM (rpm)	Eng 1 Torque (%)	Eng 2 Torque (%)	Eng 1 NH (%rpm)	Eng 2 NH (%rpm)	Roll Attitude	Rudder Positon
16:09:08,000			0,799				655,7		28,8				
16:09:08,125			1,385							72,2		14,1	
16:09:08,250			0,984										
16:09:08,375			0,918	Not Beta	Not Beta								-15,1
16:09:08,500			1,277			827,8		6,3					
16:09:08,625	64,5	252,2	1,101							68,4		14,8	
16:09:08,750			1,046										
16:09:08,875			1,11										-15,1
16:09:09,000			1,185				331,1		26,6				
16:09:09,125			1,158							73,5		13,4	
16:09:09,250			1,03										
16:09:09,375			0,927	Not Beta	Not Beta								-15,2

The aircraft slid off runway 23 and departed the runway to the right.

The directional control of the aircraft was controlled by the use of the rudder. The rudder was in a full left deflection (-15). The CAS had dropped to 64.5 knots making the rudder less effective.

Both the engine turbines were running. The propeller on engine #1 was still producing forward power (6.3% torque)]. The propeller on engine #2 appeared to produce forward power (28.8% to 26.6% torque) but the outer parts of the propeller blades were gone.

Time 16:09:13 – the aircraft came to rest



UTC	CAS	MH	Vertical Accel (g's)	Prop Beta Eng#1	Prop Beta Eng#2	Prop 1 RPM (rpm)	Prop 2 RPM (rpm)	Eng 1 Torque (%)	Eng 2 Torque (%)	Eng 1 NH (%rpm)	Eng 2 NH (%rpm)
16:09:13,000			0,954				33,7		0,1		
16:09:13,125			0,975							74,7	
16:09:13,250			0,963								
16:09:13,375			0,931	Not Beta	Not Beta						
16:09:13,500			0,947			797,4		15,6			
16:09:13,625	31,5	301,3	0,973								30,2
16:09:13,750			0,947								
16:09:13,875			0,938								
16:09:14,000			0,931				8,4		0,3		
16:09:14,125			0,954							74,6	
16:09:14,250			0,954								
16:09:14,375			0,991	Not Beta	Not Beta						
16:09:14,500			0,982			789,7		15			

The aircraft came to rest to the right of runway 23.

Both the engine turbines were still running. The propeller on engine #1 had increased the forward power to around 15.0% torque. The propeller on engine #2 did not to produce any forward power (0.3% torque).

The aircraft pitch angle was +2° nose up and the bank angle was 13° right wing down.

Vertical acceleration during flight

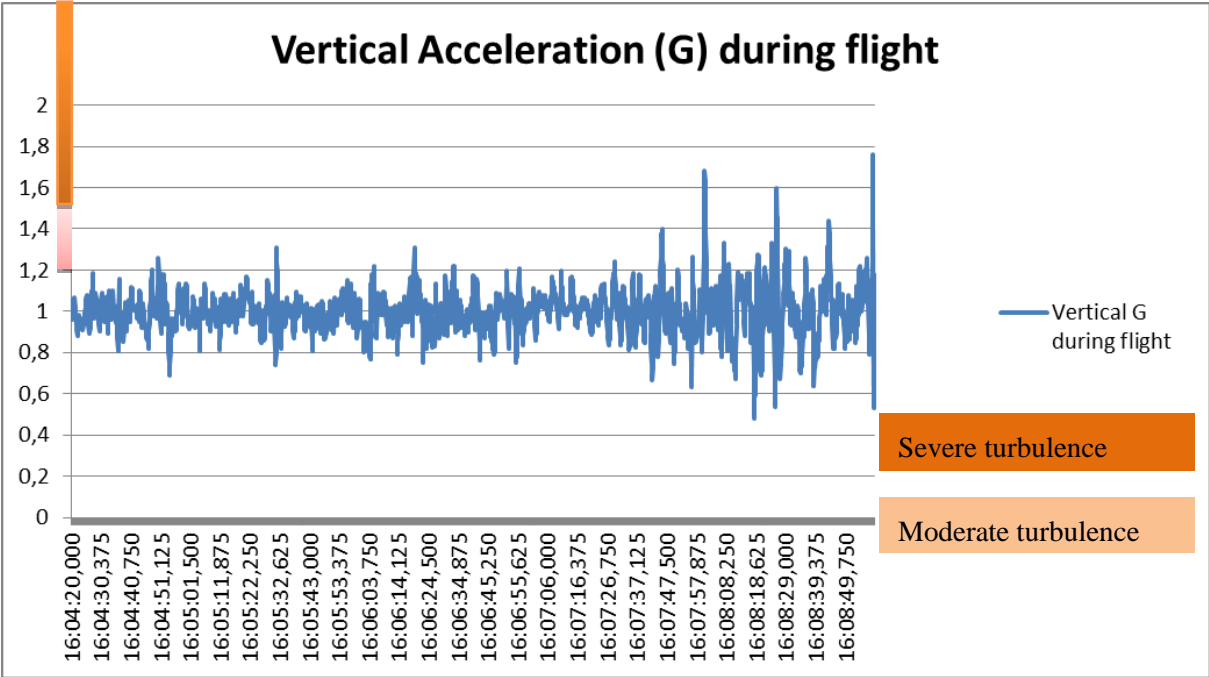

Appendix 2 – FDR plots

The approach

Approach

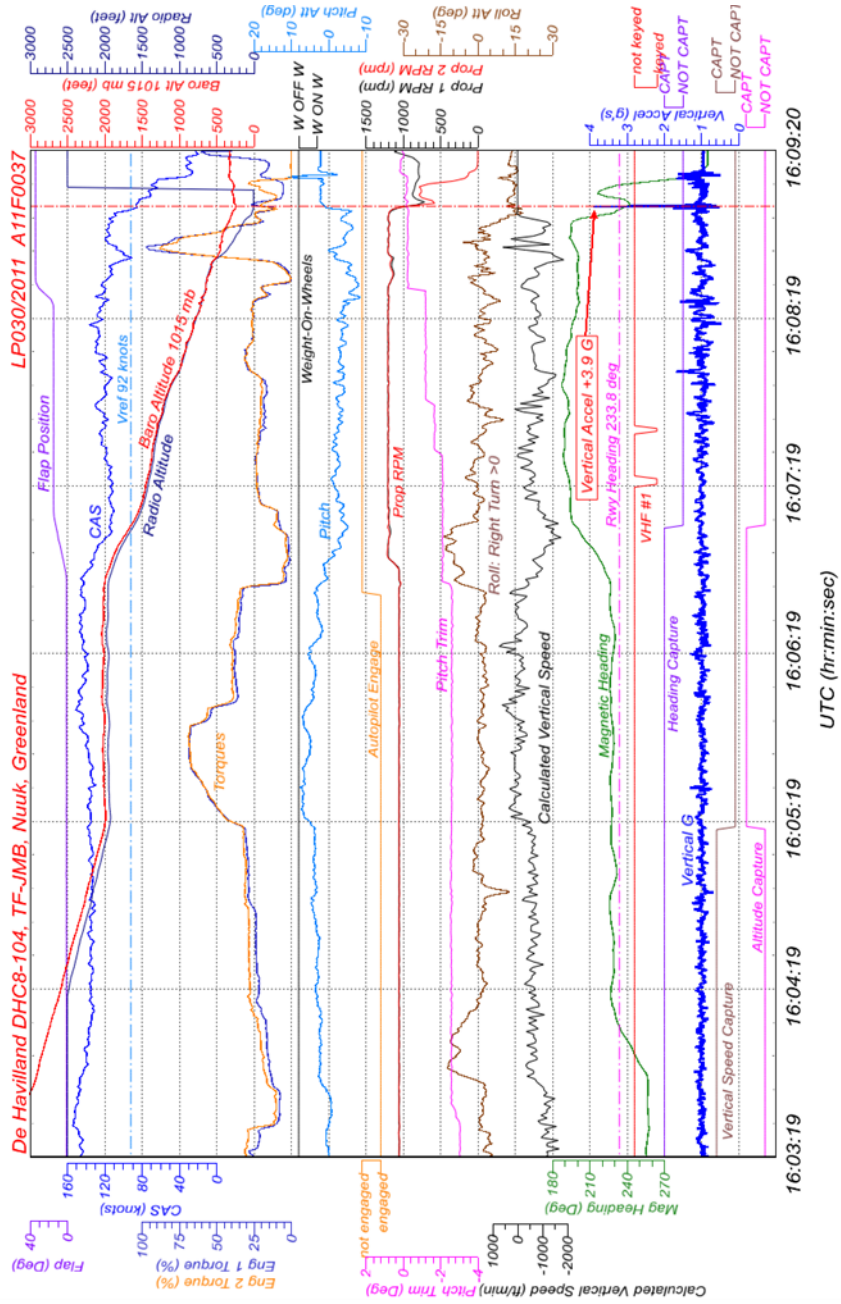

Recorders & Vehicle Performance Division - TSBC

Created: 12 September, 2011

The landing

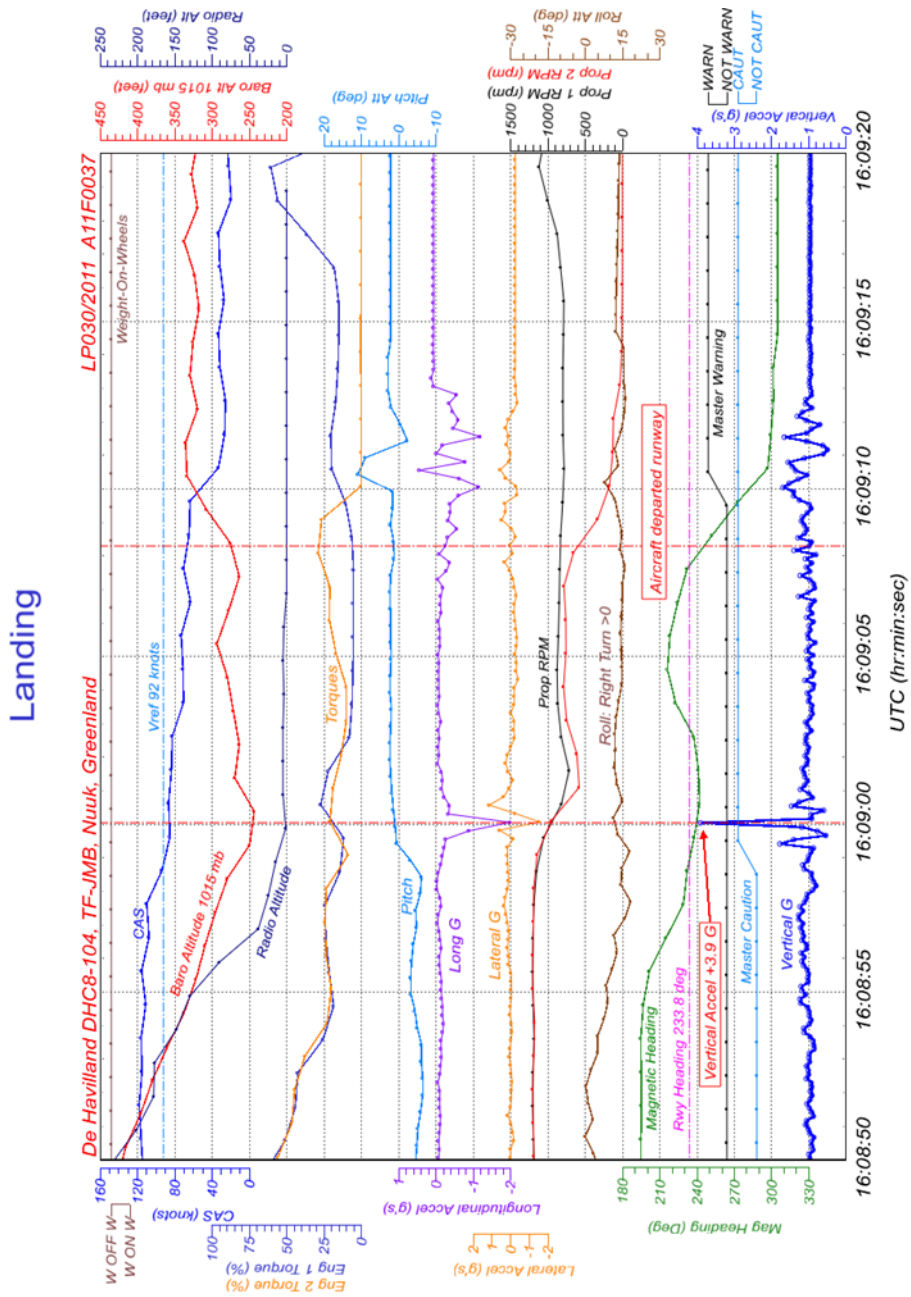

Recorders & Vehicle Performance Division - TSBC

Created: 12 September, 2011

Longitudinal controls

Longitudinal Controls

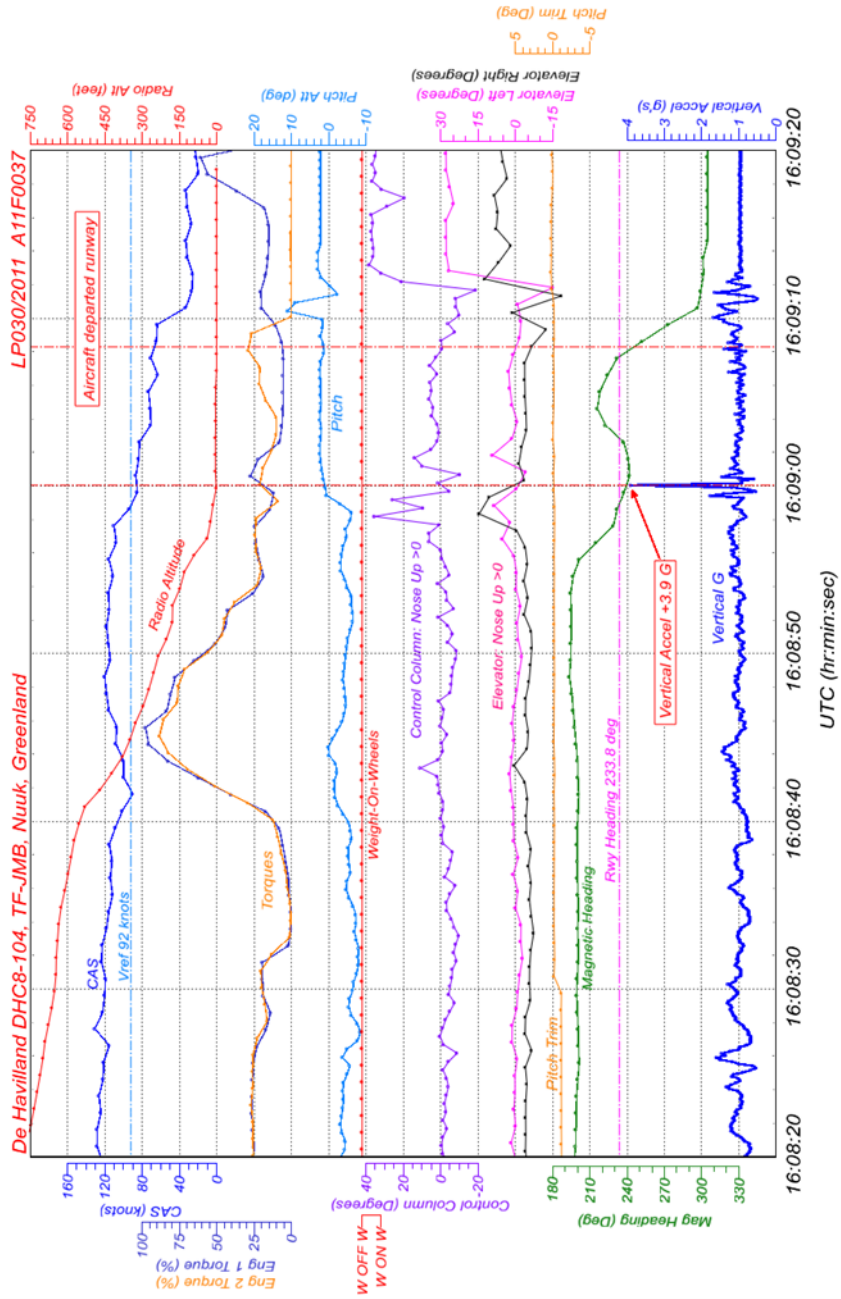

Created: 12 September, 2011

Recorders & Vehicle Performance Division - TSBC

Lateral and directional controls

Lateral / Directional Controls

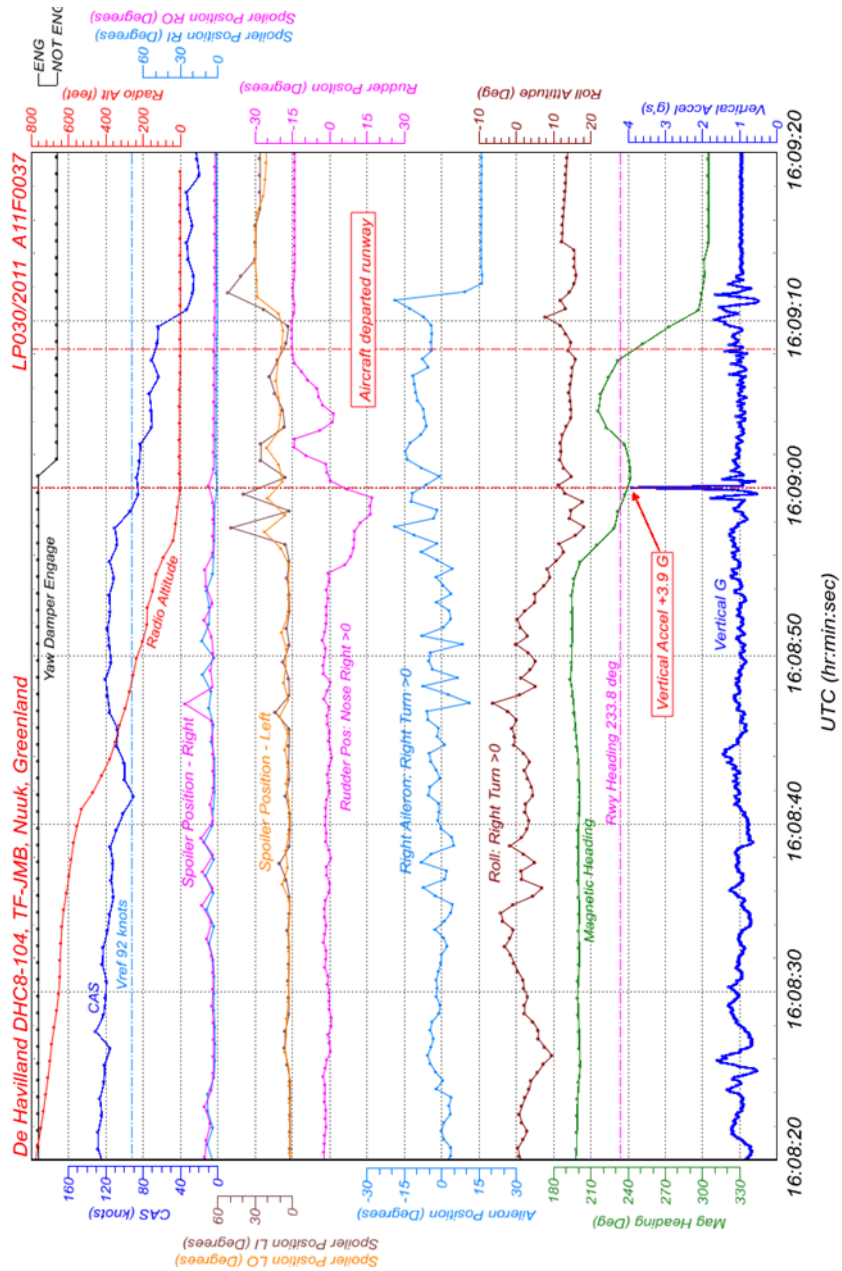

Created: 12 September, 2011

Recorders & Vehicle Performance Division - TSBC

Engines and propellers

Engines/Propellers

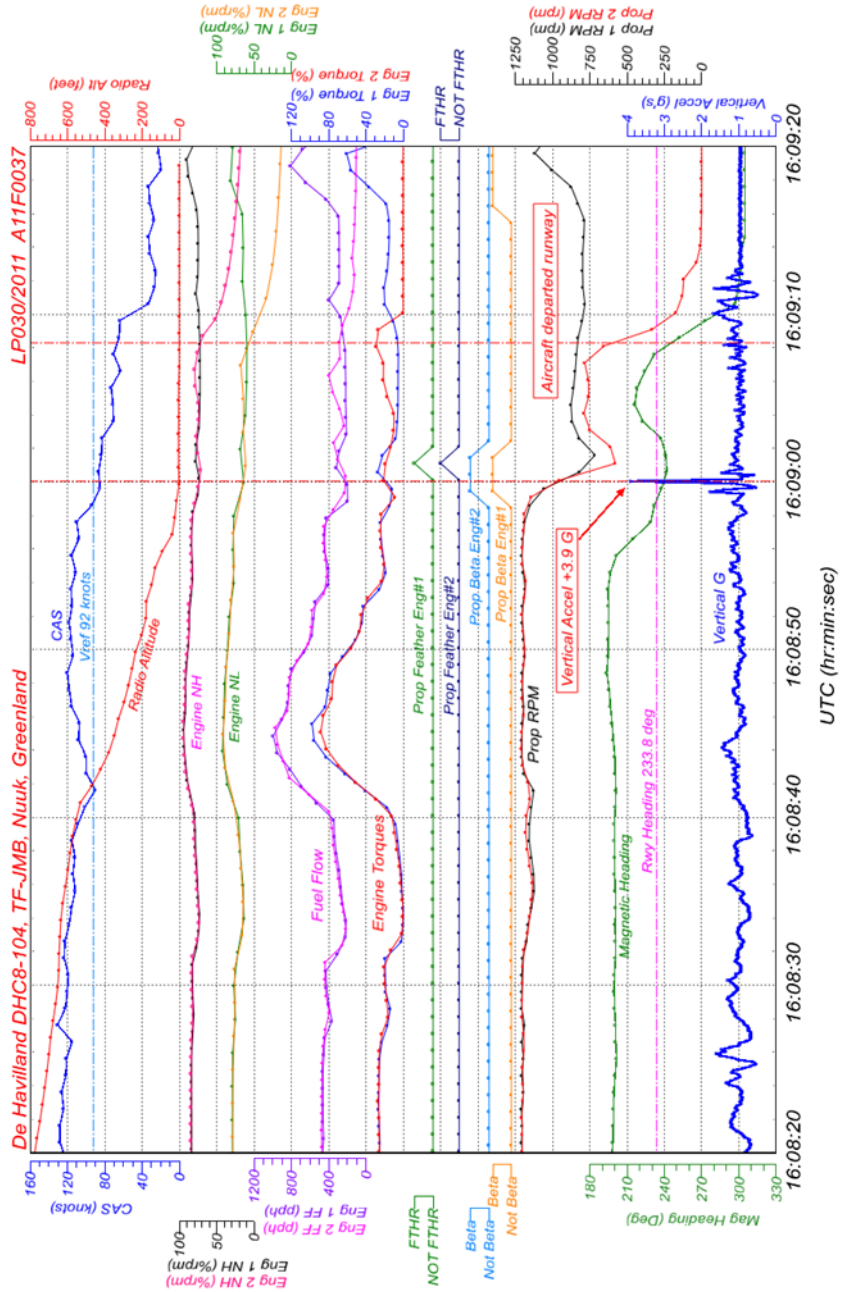

Created: 12 September, 2011

Recorders & Vehicle Performance Division - TSBC

Navigation

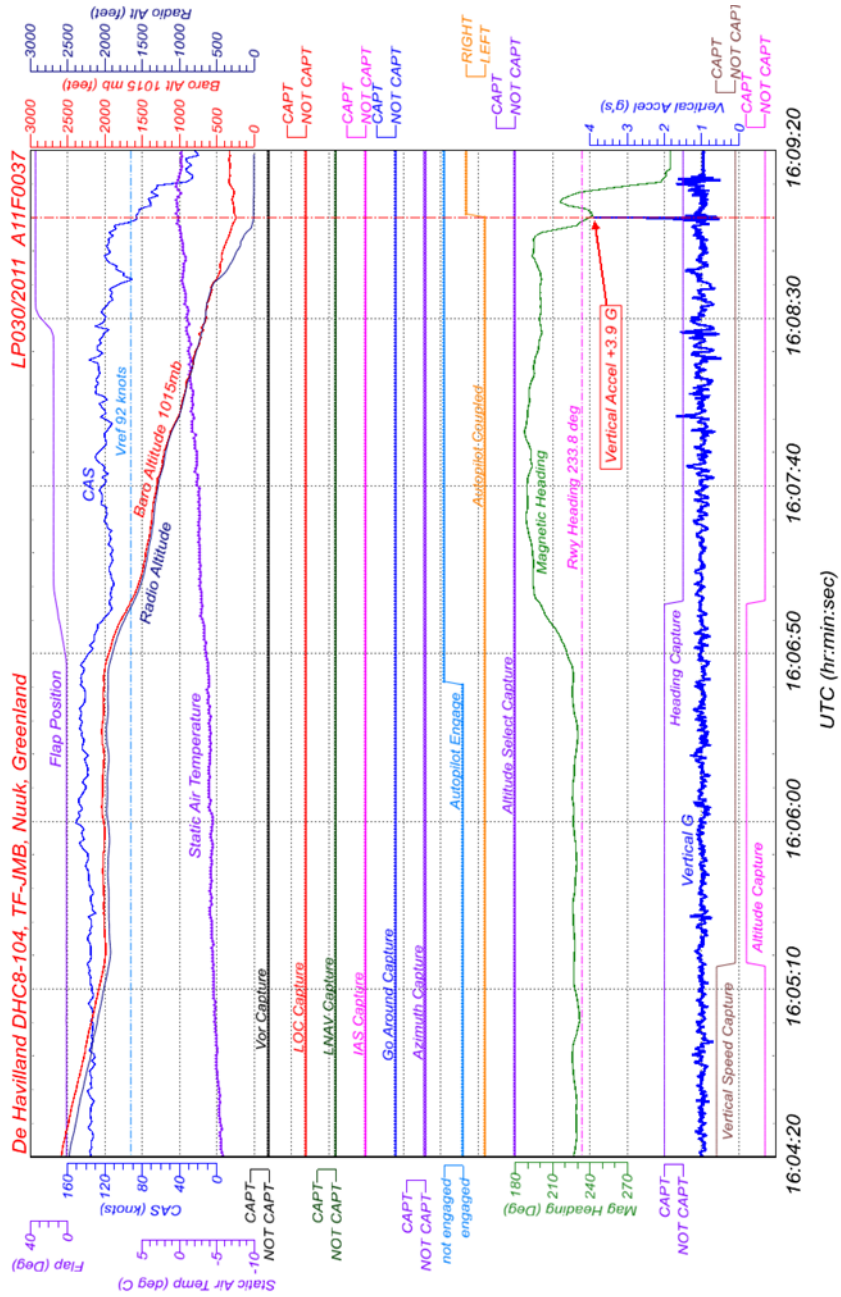

Created: 12 September, 2011

Recorders & Vehicle Performance Division - TSBC

Appendix 3 – BGGH aerodrome and procedure briefing

SUBJECT: Nuuk (BGGH/GOH)

ATS Airspace

Airspace class:	G - Traffic Information Zone (TIZ)
Callsign: Nuuk	AFIS
Lateral limits:	20 NM radius.
Vertical limit:	8000 feet.
Transition Alt:	7000 feet

Aerodrome

BGGH is located on the south east side of Godthåbsfjord on a hill above Nuuk city.

Airport elevation is 283ft.

One strip is available - 05/23. Length 950m, width 30m.

- PAPI available for both runways, angle 3°.

- Approach Lights available for Rwy 23.

- All obstacles are marked by day and night.

NOTE: East of the extended centerline Rwy 23, PAPI will only give sufficient obstacle clearance within 11°.

Terrain

Terrain close to the instrument approach, missed approach and circling flight paths:

- Mountainous islands and headlands E of the instrument approach. Closest to the LOC approach path is a 1969ft hill, approx. 5NM N of the field.

- Hills, 1411ft. and 2660ft. just east of the airfield.

Extreme caution should be exercised when flying in fjords, valleys or near islands along the coast due to transmission lines, (see Visual Approach chart).

Weather

Due to the high terrain in the immediate vicinity of the airfield, large wind variations and turbulence may be expected with the wind from easterly directions. There is a frequent risk of fog and low stratus.

LRC Flight Planning

If aircraft tank capacity does not allow at least 100kg in excess of the Minimum Fuel Required, when Long Range Cruise is used for flight planning, it should be considered to delay the flight. If weather conditions at destination are above Destination Alternate minimums and icing conditions are not expected along the planned route, the commander may find it acceptable to depart with less extra fuel than described above.

When Long Range Cruise is used for flight planning, it is recommended that a flight plan based on Normal Cruise, also be on board for comparison during the flight.

Operational Limitations

- Whenever the 2 minute wind is more than 35kts DAY or 20kts NIGHT (steady or gusting) from the sector 130°- 190° M (steady or variable), landings are prohibited and take-off allowed Rwy 23 only.
- From other directions, the maximum wind is 50kts notwithstanding the relevant x-wind limit.

Navigation and Communication

Clearance to descend below controlled airspace (FL195) shall be obtained from **ICELAND RADIO 127.85** or **HF 4675/8891**. Contact **SONDRESTROM Information 121.3** or **HF 5526/8945** for traffic information below FL195.

Nuuk **119.1** is AFIS only, but has a Traffic Information Zone, which means that two-way communication with the AFIS is necessary whenever flying with-in the zone.

If unable to make contact using the published frequencies, use the on board SAT Phone (DH-8 only). Useful telephone numbers:

Sondrestrom Information: 00 299 84 11 35

Nuuk AFIS: 00 299 32 75 53

Iceland Radio: 00 354 563 6502

Reykjavík Control: 00 354 424 4343

Communication Failure: Jeppesen EMERGENCY, Chapter 6.

ATS Routes

See Jeppesen Air Traffic Control – Greenland 1-4

En-route Terrain Clearance

Under ISA conditions both the F50 and DH8 meet or exceed the MOCA (Minimum Obstruction Clearance Alt) requirements for flights to destinations across the Greenland ice cap and for a diversion from GOH to SFJ or UAK.

Arrival Procedure

When approaching Nuuk from the east, plan the approach via NUTKA. It is recommended to fly direct NUTKA from 050W.

Although it is only necessary to check the 2 minute winds before landing, pilots are encouraged to ask for and evaluate the 10 minute winds for the possibility of turbulence whenever easterly winds approach the allowable limits.

Approach

LOC DME -3 approach (Jeppesen Chart 11-1 LOC DME 1 & 3 Rwy 23), is recommended, either straight-in Rwy 23 or for a circling approach Rwy 05. The localizer is 4° offset from the extended runway center line.

Minimum Approach Visibility:

LOC DME-1, 2 & 3: Straight in Rwy 23: 1800m.

Circling Rwy 05: 4000m.

Circling NDB DME-1 & 2: Circling Rwy 05/23: 6500m.

Landing RWY 05

Circle west of runway only.

Departure

Minimum T/O visibility, either runway: 600m.

When winds are from easterly directions, the 30 minute maximum and minimum winds should be obtained from AFIS, (preferably before boarding the aircraft). If this wind is outside the limits for the 2 minute wind, take-off Rwy 05 is not allowed and shall be delayed until such time as the 30 minute wind is within the limits.

Take-off Rwy 05

Climb straight ahead. At D3.0/GN turn LEFT. Intercept QDM 239 to GH Locator. If necessary climb in GH holding until reaching MEA.

Take-off Rwy 23

Climb straight ahead. At D2.5/GN turn RIGHT to KU Locator (298 kHz). Passing KU Lctr or 3000ft, turn RIGHT and proceed to GH Locator. If necessary climb in GH holding until reaching MEA.

Handling / On ground

Grønlands Lufhavsvæsen (GLV) is the handling agent.

Air Greenland can provide De-Icing service during opening hours.

Attachments:

1. Visual Approach Chart

Attachment 1

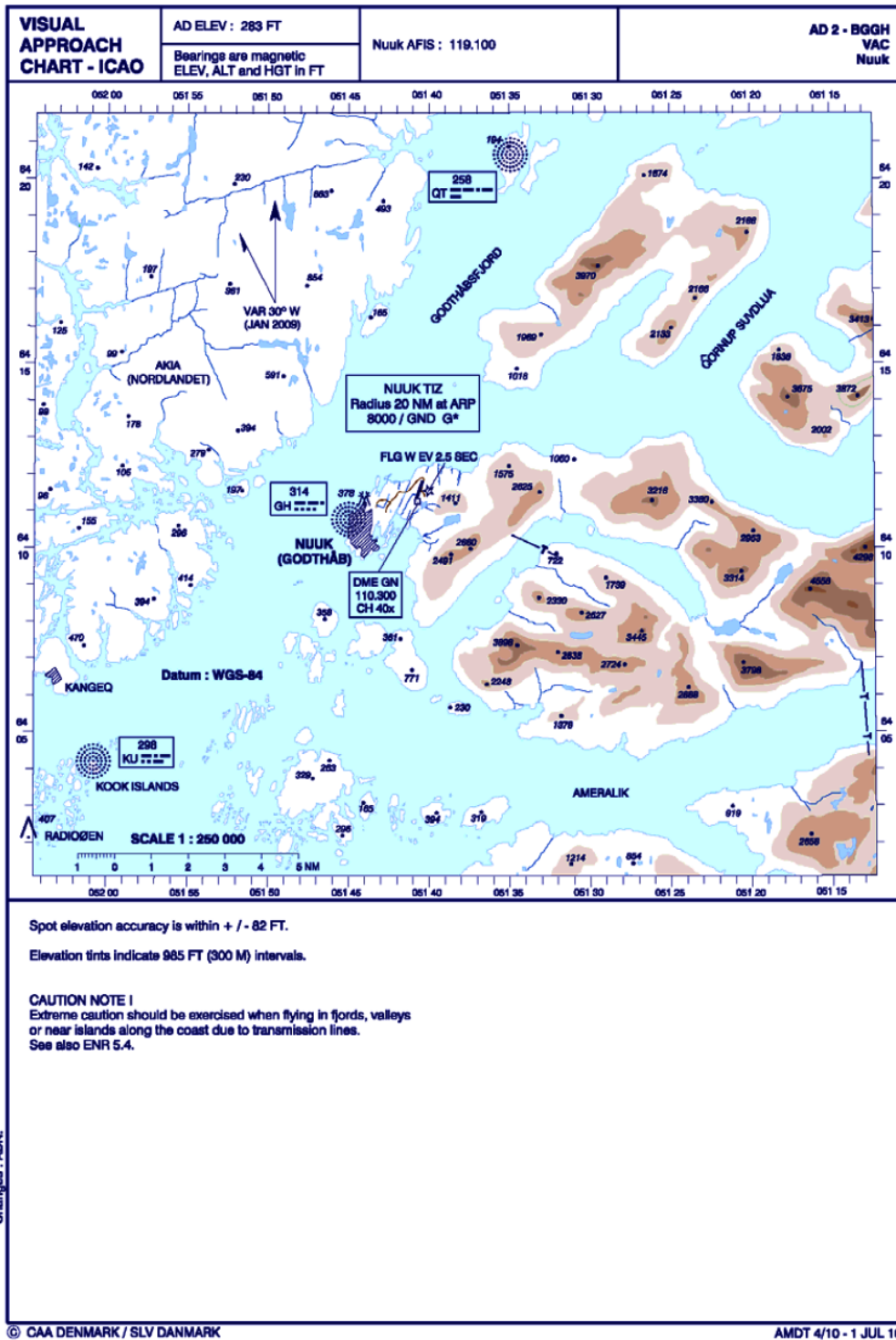

Appendix 4 – Stabilized approach policy

1.2 STABILIZED APPROACH POLICY

The aircraft is considered to be stabilized for an approach to land from start of final descent until crossing threshold, when the following conditions are met:

	Type of approach		Gates to be stabilized (AGL)		Incapac. - call @ (AGL)	Maximum deviation	
			VMC	IMC		Vertical	Horizontal
Flight path	Precision	GCA	500 ft	1000 ft	1000 & 500 ft	According GCA controller	
		ILS	500 ft	1000 ft	1000 & 500 ft	One dot on GP	One dot on LOC
	Non – precision	CANPA *1	500 ft	1000 ft	1000 & 500 ft	150 ft below advisory altitude after FAF	Established on inbound course +/- 5°
		Non CANPA *2	500 ft	1000 ft	1000 & 500 ft	Maximum bank angle below 500 ft AAL for a correction to RWY centerline is 20°; MAP must not be passed *3	
		Visual	500 ft	N/A	1000 & 500 ft	Not below minimum altitudes after FAF	Established on inbound course +/- 5°
	N/A	Circling	300 ft	N/A	1000 & 500 ft	Maximum bank angle below 500 ft AAL for a correction to RWY centerline is 20°; MAP must not be passed *3	
Maximum bank angle for turn to final track below 500 ft AAL is 25°; *3							
Speed	V _{REF}					Min Vref - 5 kts/Max Vref + 15 kts	
Configuration	Flaps	Precision				15°	
		NPA	CANPA				
			Conventional				
		Visual/Circling					
	Gear					Down	
ROD	Above gate : 1500 ft/min Below gate : 1000 ft/min (except during steep approach up to 1500 ft/min)						
Power	Condition levers set as intended for landing; only small changes in engine power						

If not stabilized at gates, execute a Go-around (see Chapter 02.12 Missed Approach)

*** 1: Note: CANPA = constant angle non-precision approach**

*** 2: Note: Non - CANPA = non-constant angle non-precision approach**

*** 3: Note: wings required to be level (or as to compensate crosswind) latest at 300 ft AGL.**