



SECURINESS

Miljøvenlig Gadebelysning





45 80 33 22  Kontakt os venligst for mere information

MILJØVENLIG OG GRØN GADEBELYSNING

Sol og Vind hybrid gadebelysning

Vores Sol og Vind Gadebelysning er et intelligent system med LED lys. Denne autonome løsning indeholder sol modul og vindmølle, PV batteri, controller og LED lys. Den hybride gadelampe benytter sig udelukkende af sol og vind som energikilde og hele systemet er praktisk talt vedligeholdelsesfrit og helt uden daglige omkostninger af nogen art.



-  24V opladning / udledning.
-  MEPT (max power point tracking) teknologi, hvilket øger opladningseffektiviteten med 6 – 30%.
-  Optimeret PV gel batteri. Vores PV gel-batterier er udstyret med lav afladning og har en lang levetid uden erosion, forurening af nogen art.
-  Automatisk lys graduering via forud indstillings funktion.
-  Automatisk lys overvågning af batteriets kapacitet.

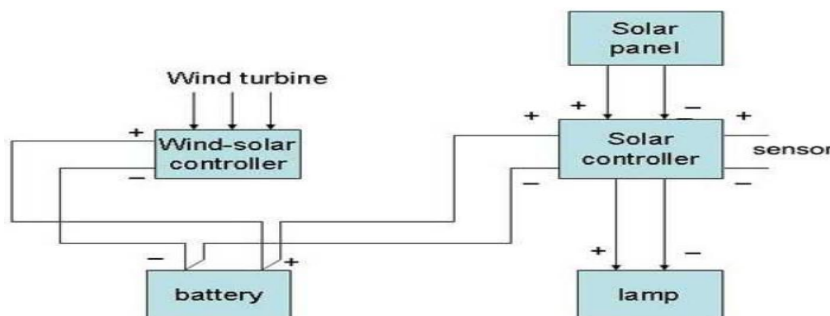

SECURINESS

| Stenlandsvej 12 | 2300 København S | +45 45 80 33 22 | www.securiness.com

Anbefalet konfiguration af Sol og Vind hybrid systemer til 45W LED gadelampe.

Configuration	Description	Usage	Life span
LED Street light	45W LED street light, DC24V.2800LM	1 pc	50,000 hrs
Solar module	65W mono-crystalline silicon solar modules	2 pcs	25 years
Wind turbine	400W 12V/24V	1 set	15 years
PV battery	12V 80AH lead-acid gel battery	2 pcs	12 years
Controller	micro-computer intelligent control	1 pc	5years
Poles	7m hot-dipped galvanization	1 set	20 years
Others	bracket of modules and battery cabinet	1 set	

Anbefalet konfiguration af Sol og Vind hybrid systemer til 60W LED gadelampe.

Configuration	Description	Usage	Life span
LED Street light	60W LED street light, DC24V, 3400LM	1 pc	50,000 hrs
Solar module	65W mono-crystalline silicon solar modules	2 pcs	25 years
Wind turbine	400W 12V/24V	1 set	15 years
PV battery	12V 100AH lead-acid gel battery	2 pcs	12 years
Controller	micro-computer intelligent control	1 pc	5years
Poles	8m hot-dipped galvanization	1 set	20 years
Others	bracket of modules and battery cabinet	1 set	

Anbefalet konfiguration af Sol og Vind hybrid systemer til 80W LED gadelampe.

Configuration	Description	Usage	Life span
LED Street light	80W LED street light, DC24V.2800LM	1 pc	50,000 hrs
Solar module	85W mono-crystalline silicon solar modules	2 pcs	25 years
Wind turbine	800W 12V/24V	1 set	15 years
PV battery	12V 150AH lead-acid gel battery	2 pcs	12 years
Controller	micro-computer intelligent control	1 pc	5years
Poles	9m hot-dipped galvanization	1 set	20 years
Others	bracket of modules and battery cabinet	1 set	



Physical Dimension

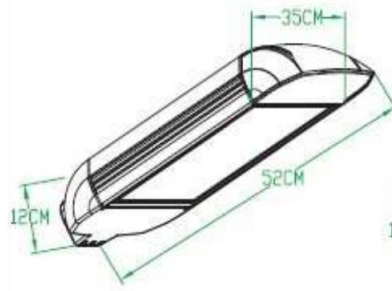

45W LED Street light

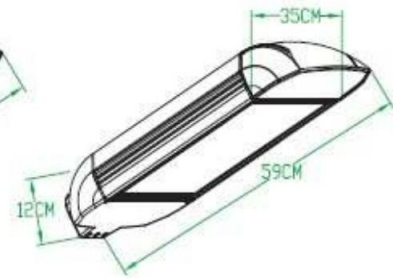

60W/80W LED Street light

